

POWER WAVE™ 455 MFor use with machines having Code Numbers: **10942, 11057, 11152, 11311****Safety Depends on You**

Lincoln arc welding and cutting equipment is designed and built with safety in mind. However, your overall safety can be increased by proper installation ... and thoughtful operation on your part. **DO NOT INSTALL, OPERATE OR REPAIR THIS EQUIPMENT WITHOUT READING THIS MANUAL AND THE SAFETY PRECAUTIONS CONTAINED THROUGHOUT.** And, most importantly, think before you act and be careful.

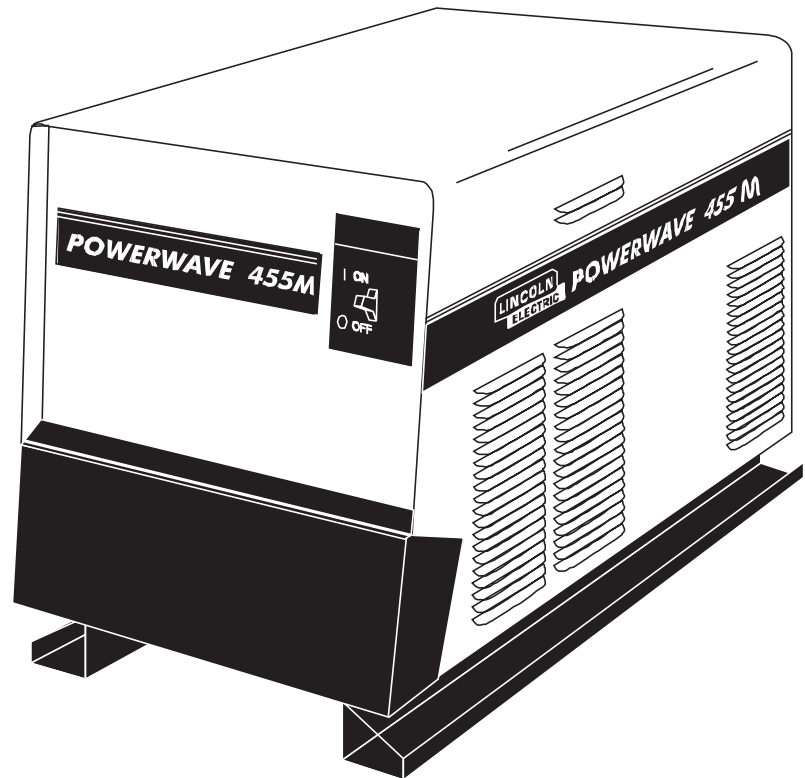

IEC 60974-1

OPERATOR'S MANUAL**LINCOLN®
ELECTRIC**

Copyright © 2006 Lincoln Global Inc.

- World's Leader in Welding and Cutting Products •
- Sales and Service through Subsidiaries and Distributors Worldwide •

Cleveland, Ohio 44117-1199 U.S.A. TEL: 216.481.8100 FAX: 216.486.1751 WEB SITE: www.lincolnelectric.com

⚠ WARNING

⚠ CALIFORNIA PROPOSITION 65 WARNINGS ⚠

Diesel engine exhaust and some of its constituents are known to the State of California to cause cancer, birth defects, and other reproductive harm.

The Above For Diesel Engines

The engine exhaust from this product contains chemicals known to the State of California to cause cancer, birth defects, or other reproductive harm.

The Above For Gasoline Engines

ARC WELDING CAN BE HAZARDOUS. PROTECT YOURSELF AND OTHERS FROM POSSIBLE SERIOUS INJURY OR DEATH. KEEP CHILDREN AWAY. PACEMAKER WEARERS SHOULD CONSULT WITH THEIR DOCTOR BEFORE OPERATING.

Read and understand the following safety highlights. For additional safety information, it is strongly recommended that you purchase a copy of "Safety in Welding & Cutting - ANSI Standard Z49.1" from the American Welding Society, P.O. Box 351040, Miami, Florida 33135 or CSA Standard W117.2-1974. A Free copy of "Arc Welding Safety" booklet E205 is available from the Lincoln Electric Company, 22801 St. Clair Avenue, Cleveland, Ohio 44117-1199.

BE SURE THAT ALL INSTALLATION, OPERATION, MAINTENANCE AND REPAIR PROCEDURES ARE PERFORMED ONLY BY QUALIFIED INDIVIDUALS.



FOR ENGINE powered equipment.

1.a. Turn the engine off before troubleshooting and maintenance work unless the maintenance work requires it to be running.



1.b. Operate engines in open, well-ventilated areas or vent the engine exhaust fumes outdoors.



1.c. Do not add the fuel near an open flame welding arc or when the engine is running. Stop the engine and allow it to cool before refueling to prevent spilled fuel from vaporizing on contact with hot engine parts and igniting. Do not spill fuel when filling tank. If fuel is spilled, wipe it up and do not start engine until fumes have been eliminated.

1.d. Keep all equipment safety guards, covers and devices in position and in good repair. Keep hands, hair, clothing and tools away from V-belts, gears, fans and all other moving parts when starting, operating or repairing equipment.

1.e. In some cases it may be necessary to remove safety guards to perform required maintenance. Remove guards only when necessary and replace them when the maintenance requiring their removal is complete. Always use the greatest care when working near moving parts.



1.f. Do not put your hands near the engine fan. Do not attempt to override the governor or idler by pushing on the throttle control rods while the engine is running.

1.g. To prevent accidentally starting gasoline engines while turning the engine or welding generator during maintenance work, disconnect the spark plug wires, distributor cap or magneto wire as appropriate.



1.h. To avoid scalding, do not remove the radiator pressure cap when the engine is hot.

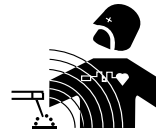

ELECTRIC AND MAGNETIC FIELDS may be dangerous

2.a. Electric current flowing through any conductor causes localized Electric and Magnetic Fields (EMF). Welding current creates EMF fields around welding cables and welding machines

2.b. EMF fields may interfere with some pacemakers, and welders having a pacemaker should consult their physician before welding.

2.c. Exposure to EMF fields in welding may have other health effects which are now not known.

2.d. All welders should use the following procedures in order to minimize exposure to EMF fields from the welding circuit:

2.d.1. Route the electrode and work cables together - Secure them with tape when possible.

2.d.2. Never coil the electrode lead around your body.

2.d.3. Do not place your body between the electrode and work cables. If the electrode cable is on your right side, the work cable should also be on your right side.

2.d.4. Connect the work cable to the workpiece as close as possible to the area being welded.

2.d.5. Do not work next to welding power source.

Mar '95



ELECTRIC SHOCK can kill.

- 3.a. The electrode and work (or ground) circuits are electrically "hot" when the welder is on. Do not touch these "hot" parts with your bare skin or wet clothing. Wear dry, hole-free gloves to insulate hands.
- 3.b. Insulate yourself from work and ground using dry insulation. Make certain the insulation is large enough to cover your full area of physical contact with work and ground.
- In addition to the normal safety precautions, if welding must be performed under electrically hazardous conditions (in damp locations or while wearing wet clothing; on metal structures such as floors, gratings or scaffolds; when in cramped positions such as sitting, kneeling or lying, if there is a high risk of unavoidable or accidental contact with the workpiece or ground) use the following equipment:**
- Semiautomatic DC Constant Voltage (Wire) Welder.
 - DC Manual (Stick) Welder.
 - AC Welder with Reduced Voltage Control.
- 3.c. In semiautomatic or automatic wire welding, the electrode, electrode reel, welding head, nozzle or semiautomatic welding gun are also electrically "hot".
- 3.d. Always be sure the work cable makes a good electrical connection with the metal being welded. The connection should be as close as possible to the area being welded.
- 3.e. Ground the work or metal to be welded to a good electrical (earth) ground.
- 3.f. Maintain the electrode holder, work clamp, welding cable and welding machine in good, safe operating condition. Replace damaged insulation.
- 3.g. Never dip the electrode in water for cooling.
- 3.h. Never simultaneously touch electrically "hot" parts of electrode holders connected to two welders because voltage between the two can be the total of the open circuit voltage of both welders.
- 3.i. When working above floor level, use a safety belt to protect yourself from a fall should you get a shock.
- 3.j. Also see Items 6.c. and 8.



ARC RAYS can burn.

- 4.a. Use a shield with the proper filter and cover plates to protect your eyes from sparks and the rays of the arc when welding or observing open arc welding. Headshield and filter lens should conform to ANSI Z87.1 standards.
- 4.b. Use suitable clothing made from durable flame-resistant material to protect your skin and that of your helpers from the arc rays.
- 4.c. Protect other nearby personnel with suitable, non-flammable screening and/or warn them not to watch the arc nor expose themselves to the arc rays or to hot spatter or metal.



FUMES AND GASES can be dangerous.

- 5.a. Welding may produce fumes and gases hazardous to health. Avoid breathing these fumes and gases. When welding, keep your head out of the fume. Use enough ventilation and/or exhaust at the arc to keep fumes and gases away from the breathing zone. **When welding with electrodes which require special ventilation such as stainless or hard facing (see instructions on container or MSDS) or on lead or cadmium plated steel and other metals or coatings which produce highly toxic fumes, keep exposure as low as possible and below Threshold Limit Values (TLV) using local exhaust or mechanical ventilation. In confined spaces or in some circumstances, outdoors, a respirator may be required. Additional precautions are also required when welding on galvanized steel.**
5. b. The operation of welding fume control equipment is affected by various factors including proper use and positioning of the equipment, maintenance of the equipment and the specific welding procedure and application involved. Worker exposure level should be checked upon installation and periodically thereafter to be certain it is within applicable OSHA PEL and ACGIH TLV limits.
- 5.c. Do not weld in locations near chlorinated hydrocarbon vapors coming from degreasing, cleaning or spraying operations. The heat and rays of the arc can react with solvent vapors to form phosgene, a highly toxic gas, and other irritating products.
- 5.d. Shielding gases used for arc welding can displace air and cause injury or death. Always use enough ventilation, especially in confined areas, to insure breathing air is safe.
- 5.e. Read and understand the manufacturer's instructions for this equipment and the consumables to be used, including the material safety data sheet (MSDS) and follow your employer's safety practices. MSDS forms are available from your welding distributor or from the manufacturer.
- 5.f. Also see item 1.b.

AUG 06

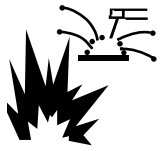

WELDING SPARKS can cause fire or explosion.

6.a. Remove fire hazards from the welding area. If this is not possible, cover them to prevent the welding sparks from starting a fire.

Remember that welding sparks and hot materials from welding can easily go through small cracks and openings to adjacent areas. Avoid welding near hydraulic lines. Have a fire extinguisher readily available.

- 6.b. Where compressed gases are to be used at the job site, special precautions should be used to prevent hazardous situations. Refer to "Safety in Welding and Cutting" (ANSI Standard Z49.1) and the operating information for the equipment being used.
- 6.c. When not welding, make certain no part of the electrode circuit is touching the work or ground. Accidental contact can cause overheating and create a fire hazard.
- 6.d. Do not heat, cut or weld tanks, drums or containers until the proper steps have been taken to insure that such procedures will not cause flammable or toxic vapors from substances inside. They can cause an explosion even though they have been "cleaned". For information, purchase "Recommended Safe Practices for the Preparation for Welding and Cutting of Containers and Piping That Have Held Hazardous Substances", AWS F4.1 from the American Welding Society (see address above).
- 6.e. Vent hollow castings or containers before heating, cutting or welding. They may explode.
- 6.f. Sparks and spatter are thrown from the welding arc. Wear oil free protective garments such as leather gloves, heavy shirt, cuffless trousers, high shoes and a cap over your hair. Wear ear plugs when welding out of position or in confined places. Always wear safety glasses with side shields when in a welding area.
- 6.g. Connect the work cable to the work as close to the welding area as practical. Work cables connected to the building framework or other locations away from the welding area increase the possibility of the welding current passing through lifting chains, crane cables or other alternate circuits. This can create fire hazards or overheat lifting chains or cables until they fail.
- 6.h. Also see item 1.c.

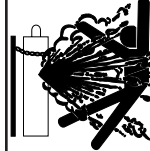

CYLINDER may explode if damaged.

7.a. Use only compressed gas cylinders containing the correct shielding gas for the process used and properly operating regulators designed for the gas and pressure used. All hoses, fittings, etc. should be suitable for the application and maintained in good condition.

- 7.b. Always keep cylinders in an upright position securely chained to an undercarriage or fixed support.
- 7.c. Cylinders should be located:
 - Away from areas where they may be struck or subjected to physical damage.
 - A safe distance from arc welding or cutting operations and any other source of heat, sparks, or flame.
- 7.d. Never allow the electrode, electrode holder or any other electrically "hot" parts to touch a cylinder.
- 7.e. Keep your head and face away from the cylinder valve outlet when opening the cylinder valve.
- 7.f. Valve protection caps should always be in place and hand tight except when the cylinder is in use or connected for use.
- 7.g. Read and follow the instructions on compressed gas cylinders, associated equipment, and CGA publication P-1, "Precautions for Safe Handling of Compressed Gases in Cylinders," available from the Compressed Gas Association 1235 Jefferson Davis Highway, Arlington, VA 22202.



FOR ELECTRICALLY powered equipment.

- 8.a. Turn off input power using the disconnect switch at the fuse box before working on the equipment.
- 8.b. Install equipment in accordance with the U.S. National Electrical Code, all local codes and the manufacturer's recommendations.
- 8.c. Ground the equipment in accordance with the U.S. National Electrical Code and the manufacturer's recommendations.

Mar '95

PRÉCAUTIONS DE SÛRETÉ

Pour votre propre protection lire et observer toutes les instructions et les précautions de sûreté spécifiques qui paraissent dans ce manuel aussi bien que les précautions de sûreté générales suivantes:

Sûreté Pour Soudage A L'Arc

1. Protégez-vous contre la secousse électrique:
 - a. Les circuits à l'électrode et à la pièce sont sous tension quand la machine à souder est en marche. Eviter toujours tout contact entre les parties sous tension et la peau nue ou les vêtements mouillés. Porter des gants secs et sans trous pour isoler les mains.
 - b. Faire très attention de bien s'isoler de la masse quand on soude dans des endroits humides, ou sur un plancher métallique ou des grilles métalliques, principalement dans les positions assis ou couché pour lesquelles une grande partie du corps peut être en contact avec la masse.
 - c. Maintenir le porte-électrode, la pince de masse, le câble de soudage et la machine à souder en bon et sûr état de fonctionnement.
 - d. Ne jamais plonger le porte-électrode dans l'eau pour le refroidir.
 - e. Ne jamais toucher simultanément les parties sous tension des porte-électrodes connectés à deux machines à souder parce que la tension entre les deux pinces peut être le total de la tension à vide des deux machines.
 - f. Si on utilise la machine à souder comme une source de courant pour soudage semi-automatique, ces précautions pour le porte-électrode s'appliquent aussi au pistolet de soudage.
2. Dans le cas de travail au dessus du niveau du sol, se protéger contre les chutes dans le cas où on recoit un choc. Ne jamais enrouler le câble-électrode autour de n'importe quelle partie du corps.
3. Un coup d'arc peut être plus sévère qu'un coup de soleil, donc:
 - a. Utiliser un bon masque avec un verre filtrant approprié ainsi qu'un verre blanc afin de se protéger les yeux du rayonnement de l'arc et des projections quand on soude ou quand on regarde l'arc.
 - b. Porter des vêtements convenables afin de protéger la peau de soudeur et des aides contre le rayonnement de l'arc.
 - c. Protéger l'autre personnel travaillant à proximité au soudage à l'aide d'écrans appropriés et non-inflammables.
4. Des gouttes de laitier en fusion sont émises de l'arc de soudage. Se protéger avec des vêtements de protection libres de l'huile, tels que les gants en cuir, chemise épaisse, pantalons sans revers, et chaussures montantes.
5. Toujours porter des lunettes de sécurité dans la zone de soudage. Utiliser des lunettes avec écrans latéraux dans les zones où l'on pique le laitier.

6. Eloigner les matériaux inflammables ou les recouvrir afin de prévenir tout risque d'incendie dû aux étincelles.
7. Quand on ne soude pas, poser la pince à une endroit isolé de la masse. Un court-circuit accidentel peut provoquer un échauffement et un risque d'incendie.
8. S'assurer que la masse est connectée le plus près possible de la zone de travail qu'il est pratique de le faire. Si on place la masse sur la charpente de la construction ou d'autres endroits éloignés de la zone de travail, on augmente le risque de voir passer le courant de soudage par les chaînes de levage, câbles de grue, ou autres circuits. Cela peut provoquer des risques d'incendie ou d'échauffement des chaînes et des câbles jusqu'à ce qu'ils se rompent.
9. Assurer une ventilation suffisante dans la zone de soudage. Ceci est particulièrement important pour le soudage de tôles galvanisées plombées, ou cadmiées ou tout autre métal qui produit des fumeés toxiques.
10. Ne pas souder en présence de vapeurs de chlore provenant d'opérations de dégraissage, nettoyage ou pistolage. La chaleur ou les rayons de l'arc peuvent réagir avec les vapeurs du solvant pour produire du phosgène (gas fortement toxique) ou autres produits irritants.
11. Pour obtenir de plus amples renseignements sur la sûreté, voir le code "Code for safety in welding and cutting" CSA Standard W 117.2-1974.

PRÉCAUTIONS DE SÛRETÉ POUR LES MACHINES À SOUDER À TRANSFORMATEUR ET À REDRESSEUR

1. Relier à la terre le châssis du poste conformément au code de l'électricité et aux recommandations du fabricant. Le dispositif de montage ou la pièce à souder doit être branché à une bonne mise à la terre.
2. Autant que possible, l'installation et l'entretien du poste seront effectués par un électricien qualifié.
3. Avant de faire des travaux à l'intérieur de poste, la débrancher à l'interrupteur à la boîte de fusibles.
4. Garder tous les couvercles et dispositifs de sûreté à leur place.

Mar. '93

Thank You

for selecting a **QUALITY** product by Lincoln Electric. We want you to take pride in operating this Lincoln Electric Company product
 ••• as much pride as we have in bringing this product to you!

Please Examine Carton and Equipment For Damage Immediately

When this equipment is shipped, title passes to the purchaser upon receipt by the carrier. Consequently, Claims for material damaged in shipment must be made by the purchaser against the transportation company at the time the shipment is received.

Please record your equipment identification information below for future reference. This information can be found on your machine nameplate.

Product _____

Model Number _____

Code Number or Date Code _____

Serial Number _____

Date Purchased _____

Where Purchased _____

Whenever you request replacement parts or information on this equipment, always supply the information you have recorded above. The code number is especially important when identifying the correct replacement parts.

On-Line Product Registration

- Register your machine with Lincoln Electric either via fax or over the Internet.
- For faxing: Complete the form on the back of the warranty statement included in the literature packet accompanying this machine and fax the form per the instructions printed on it.
- For On-Line Registration: Go to our **WEB SITE at www.lincolnelectric.com**. Choose "Quick Links" and then "Product Registration". Please complete the form and submit your registration.

Read this Operators Manual completely before attempting to use this equipment. Save this manual and keep it handy for quick reference. Pay particular attention to the safety instructions we have provided for your protection. The level of seriousness to be applied to each is explained below:

⚠ WARNING

This statement appears where the information **must** be followed **exactly** to avoid **serious personal injury** or **loss of life**.

⚠ CAUTION

This statement appears where the information **must** be followed to avoid **minor personal injury** or **damage to this equipment**.

	Page
Installation	Section A
Technical Specifications - POWER WAVE 455M	A-1
Safety Precautions.....	A-2
Select Suitable Location	A-2
Lifting.....	A-2
Stacking	A-2
Machine Grounding	A-2
High Frequency Protection	A-2
Input Connection.....	A-2
Input Fuse and Supply Wire Considerations	A-3
Input Voltage Change Over Procedure.....	A-3
Electrode and Work Cable Connections.....	A-3
Cable Inductance, and its Effects on Pulse Welding	A-4
Negative Electrode Polarity	A-4
Voltage Sensing	A-4
Power Wave to Semi-automatic Power Feed Wire Feeder Interconnections.....	A-5
System Description.....	A-5
Welding with Multiple Power Waves.....	A-6
Control Cable Specifications.....	A-6
Multiple Arc Unsynchronized	A-7
I / O Receptacle Specifications.....	A-8
Dip Switch Settings and Locations.....	A-8
Control Board Dip Switch	A-8
Water Flow Sensor.....	A-8
Operation	Section B
Safety Precautions.....	B-1
Graphic Symbols that appear on this machine or in this manual.....	B-2
Definition of Welding Terms.....	B-3
General Description	B-4
Recommended Processes and Equipment	B-4
Required Equipment	B-4
Limitations.....	B-4
Duty Cycle and Time Period	B-4
Case Front Controls	B-5
Nominal Procedures.....	B-6
Fringe Procedures.....	B-6
Making a Weld	B-6
Welding Adjustment	B-6
Constant Voltage Welding.....	B-7
Pulse Welding	B-8
Accessories	Section C
Optional Equipment	C-1
Factory Installed.....	C-1
Field Installed.....	C-1
Compatible Lincoln Equipment	C-1
Maintenance	Section D
Safety Precautions	D-1
Routine Maintenance.....	D-1
Periodic Maintenance	D-1
Calibration Specification	D-1

	Page
Troubleshooting	Section E
How to use Troubleshooting Guide	E-1
Using the Status LED to Troubleshoot System Problems	E-2
Error Codes For Power Waves.....	E-3
Troubleshooting Guide.....	E-4 thru E-6
<hr/>	
Wiring Diagram	Section F-1
Connection Diagrams	Section F-2
Dimension Print	Section F-3
<hr/>	
Parts Lists	P438 Series

TECHNICAL SPECIFICATIONS - POWER WAVE 455M (K2202-1, K2202-3)

INPUT AT RATED OUTPUT - THREE PHASE ONLY					
INPUT VOLTS-FREQUENCY	OUTPUT CONDITIONS AMPS / VOLTS / DUTY CYCLE	INPUT CURRENT AMPS	IDLE POWER	POWER FACTOR @ RATED OUTPUT	EFFICIENCY @ RATED OUTPUT
208/230/460/575V - 60HZ.	450A @ 38V. 100% 570A @ 43V. 60%	58/53/25/22 82/78/37/31	400 Watts Max.	.95 MIN.	88%
200/220/440/575V - 50HZ.	400A @ 36V. 100% 500A @ 40V. 60%	49/45/23/18 67/61/31/25			
OUTPUT					
OPEN CIRCUIT VOLTAGE	CURRENT RANGE AMPS	PULSE FREQUENCY	PULSE VOLTAGE RANGE	PULSE AND BACKGROUND TIME RANGE	AUXILIARY POWER (CIRCUIT BREAKER PROTECTED)
75 VDC	5 - 570A	0.15 - 1000 Hz	5 - 55 VDC	100 MICRO SEC. - 3.3 SEC.	40 VDC AT 10 AMPS 115VAC AT 15* AMPS
PROCESS CURRENT RANGE (DC)			CURRENT		
MIG/MAG FCAW SMAW GTAW Pulse			50-570 Average Amps 40-570 Average Amps 30-570 Average Amps 15-500 Average Amps 5-750 Peak Amps		
RECOMMENDED INPUT WIRE AND FUSE SIZES FOR MAXIMUM RATED OUTPUT					
INPUT VOLTAGE / FREQUENCY	TYPE 75°C COPPER WIRE IN CONDUIT AWG[IEC] SIZES (MM2)	TYPE 75°C GROUND WIRE IN CONDUIT AWG[IEC] SIZES (MM2)	TYPE 75°C (SUPER LAG) OR BREAKER SIZE (AMPS)		
208/50/60HZ	4(25)	6(16)	110		
230/50/60HZ	4(25)	6(16)	100		
460/50/60HZ	8(10)	10(6)	50		
575/50/60HZ	10(6)	10(6)	40		
PHYSICAL DIMENSIONS					
HEIGHT	WIDTH	DEPTH	WEIGHT		
26.10 in 663 mm	19.86 in 505 mm	32.88 in 835 mm	286 lbs. 130 kg.		
TEMPERATURE RANGES					
OPERATING TEMPERATURE RANGE -20°C to +40°C			-40°C to +40°C		

* Earlier models used 10 amps circuit breaker.

POWER WAVE 455M



SAFETY PRECAUTIONS Read this entire installation section before you start installation.



WARNING

ELECTRIC SHOCK can kill.



- Only qualified personnel should perform this installation.
- Turn the input power OFF at the disconnect switch or fuse box before working on this equipment. Turn off the input power to any other equipment connected to the welding system at the disconnect switch or fuse box before working on the equipment.

- Do not touch electrically hot parts.
- Always connect the Power Wave grounding lug (located inside the reconnect input access door) to a proper safety (Earth) ground.

SELECT SUITABLE LOCATION

Do not use Power Waves in outdoor environments. The Power Wave power source should not be subjected to falling water, nor should any parts of it be submerged in water. Doing so may cause improper operation as well as pose a safety hazard. The best practice is to keep the machine in a dry, sheltered area.

Do not mount the Power Wave 455M over combustible surfaces. Where there is a combustible surface directly under stationary or fixed electrical equipment, that surface shall be covered with a steel plate at least .060" (1.6mm) thick, which shall extend not less than 5.90" (150mm) beyond the equipment on all sides.

Place the welder where clean cooling air can freely circulate in through the rear louvers and out through the case sides and bottom. Dirt, dust, or any foreign material that can be drawn into the welder should be kept at a minimum. Do not use air filters on the air intake because the air flow will be restricted. Failure to observe these precautions can result in excessive operating temperatures and nuisance shutdowns.

Machines are equipped with F.A.N. (fan as needed) circuitry. The fan runs whenever the output is enabled, whether under loaded or open circuit conditions. The fan also runs for a period of time (approximately 5 minutes) after the output is disabled, to ensure all components are properly cooled.

If desired, the F.A.N. feature can be disabled (causing the fan to run whenever the power source is on). To disable F.A.N., connect leads 444 and X3A together at the output of the solid state fan control relay, located on the back of the Control PC board enclosure. (See Wiring Diagram)

LIFTING

Lift the machine by the lift bail only. The lift bail is designed to lift the power source only. Do not attempt to lift the Power Wave with accessories attached to it.

STACKING

Power Wave machines can be stacked to a maximum of 3 high.



CAUTION

The bottom machine must always be placed on a firm, secure, level surface. There is a danger of machines toppling over if this precaution is not taken.

MACHINE GROUNDING

The frame of the welder must be grounded. A ground terminal marked with the symbol \oplus is located inside the reconnect/input access door for this purpose. See your local and national electrical codes for proper grounding methods.

HIGH FREQUENCY PROTECTION

Locate the Power Wave away from radio controlled machinery.



CAUTION

The normal operation of the Power Wave may adversely affect the operation of RF controlled equipment, which may result in bodily injury or damage to the equipment.

INPUT CONNECTION



WARNING



Only a qualified electrician should connect the input leads to the Power Wave. Connections should be made in accordance with all local and national electrical codes and the connection diagram located on the inside of the reconnect/input access door of the machine. Failure to do so may result in bodily injury or death.

Use a three-phase supply line. A 1.75 inch (45 mm) diameter access hole for the input supply is located on the upper left case back next to the input access door. Connect L1, L2, L3 and ground according to the Input Supply Connection Diagram decal located on the inside of the input access door or refer to Figure A.1 on the following page.

POWER WAVE 455M



FIGURE A.1 - CONNECTION DIAGRAM ON CONNECTION/INPUT ACCESS DOOR

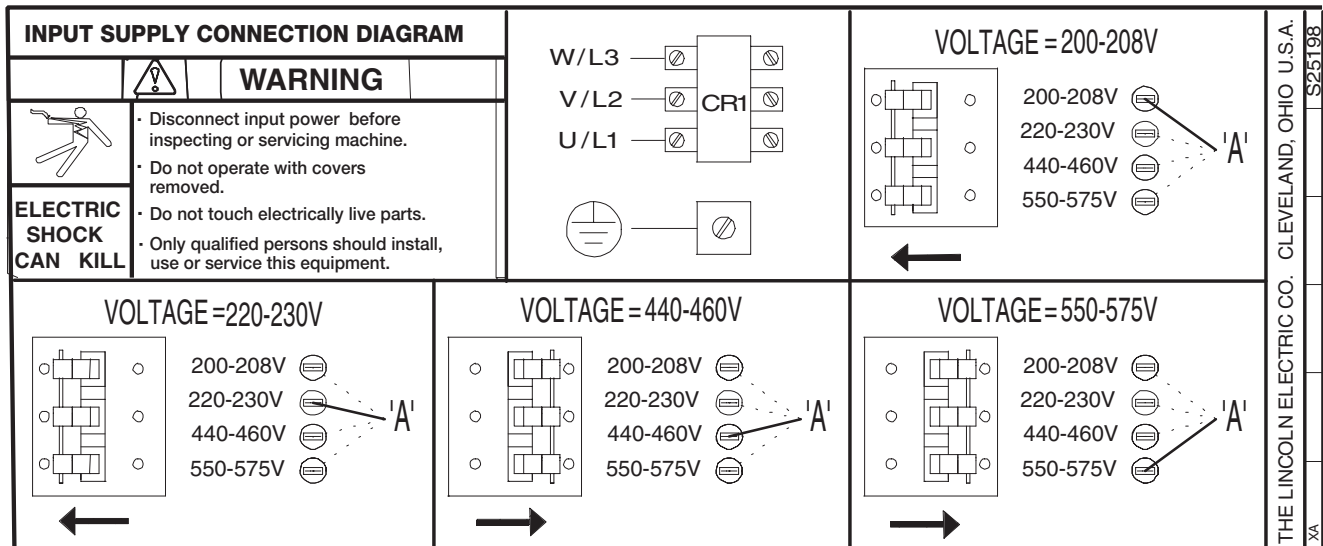

NOTE: Turn main input power to the machine OFF before performing connection procedure. Failure to do so will result in damage to the machine.

INPUT FUSE AND SUPPLY WIRE CONSIDERATIONS

Refer to the Technical Specifications at the beginning of this Installation section for recommended fuse and wire sizes. Fuse the input circuit with the recommended super lag fuse or delay type breakers (also called “inverse time” or “thermal/magnetic” circuit breakers). Choose an input and grounding wire size according to local or national electrical codes. Using fuses or circuit breakers smaller than recommended may result in “nuisance” shut-offs from welder inrush currents, even if the machine is not being used at high currents.

INPUT VOLTAGE CHANGE OVER (FOR MULTIPLE INPUT VOLTAGE MACHINES ONLY)

Welders are shipped connected for the highest input voltage listed on the rating plate. To move this connection to a different input voltage, see the diagram located on the inside of the input access door. If the main reconnect switch or link position is placed in the wrong position, the welder will not produce output power.

If the Auxiliary (A) lead is placed in the wrong position, there are two possible results. If the lead is placed in a position higher than the applied line voltage, the welder may not come on at all. If the Auxiliary (A) lead is placed in a position lower than the applied line voltage, the welder will not come on, and the two circuit breakers or fuses in the reconnect area will open. If this occurs, turn off the input voltage, properly connect the (A) lead, reset the breakers, and try again. For machines equipped with a fuse in the reconnect area, turn off the input voltage and replace the fuse with the spare fuse that is attached to the reconnect switch pin.

ELECTRODE AND WORK CABLE CONNECTIONS

Connect a work lead of sufficient size and length (Per Table 1) between the proper output terminal on the power source and the work. Be sure the connection to the work makes tight metal-to-metal electrical contact. To avoid interference problems with other equipment and to achieve the best possible operation, route all cables directly to the work and wire feeder. Avoid excessive lengths and do not coil excess cable.

Minimum work and electrode cable sizes are as follows:

TABLE A.1

(Current (60% Duty Cycle))	MINIMUM COPPER WORK CABLE SIZE AWG
	Up To-100 Ft. Length (30 m)
400 Amps	2/0 (67 mm ²)
500 Amps	3/0 (85 mm ²)
600 Amps	3/0 (85 mm ²)

NOTE: K1796 coaxial welding cable is recommended to reduce the cable inductance in long cable lengths. This is especially important when Pulse welding up to 350 amps.

CAUTION

When using inverter type power sources like the Power Waves, use the largest welding (electrode and work) cables that are practical. At least 2/0 (67 mm²) copper wire - even if the average output current would not normally require it. When pulsing, the pulse current can reach very high levels. Voltage drops can become excessive, leading to poor welding characteristics, if undersized welding cables are used.

CABLE INDUCTANCE, AND ITS EFFECTS ON PULSE WELDING

For Pulse Welding processes, cable inductance will cause the welding performance to degrade. For the total welding loop length less than 50 ft.(15.24m), traditional welding cables may be used without any effects on welding performance. For the total welding loop length greater than 50 ft.(15.24m), the K1796 Coaxial Welding Cables are recommended. The welding loop length is defined as the total of electrode cable length (A) + work cable length (B) + work length (C) (See Figure A.3).

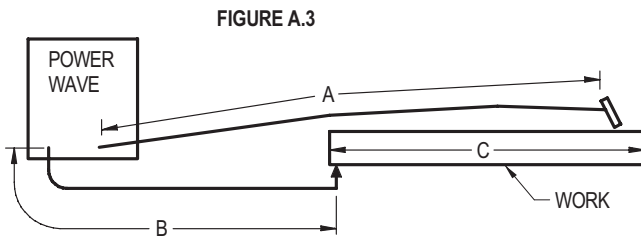

For long work piece lengths, a sliding ground should be considered to keep the total welding loop length less than 50 ft.(15.24m). (See Figure A.4.)

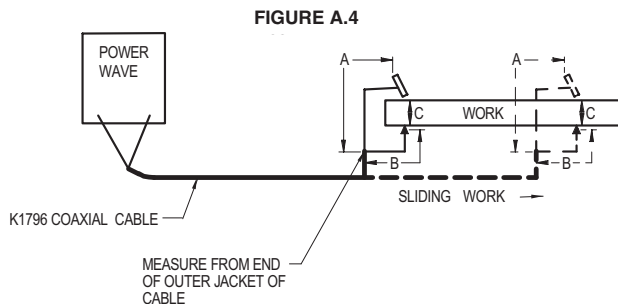

Output connections on some Power Waves are made via 1/2-13 threaded output studs located beneath the spring loaded output cover at the bottom of the case front.

Most welding applications run with the electrode being positive (+). For those applications, connect the electrode cable between the wire feeder and the positive (+) output stud on the power source (located beneath the spring loaded output cover near the bottom of the case front). Connect the other end of the electrode cable to the wire drive feed plate. The electrode cable lug must be against the feed plate. Be sure the connection to the feed plate makes tight metal-to-metal electrical contact. The electrode cable should be sized according to the specifications given in the work cable connections section. Connect a work lead from the negative (-) power source output stud to the work piece. The work piece connection must be firm and secure, especially if pulse welding is planned.

For additional Safety information regarding the electrode and work cable set-up, See the standard "SAFETY INFORMATION" located in the front of the Instruction Manuals.



CAUTION

Excessive voltage drops caused by poor work piece connections often result in unsatisfactory welding performance.

NEGATIVE ELECTRODE POLARITY

When negative electrode polarity is required, such as in some Innershield applications, switch the output connections at the power source (electrode cable to the negative (-) stud, and work cable to the positive (+) stud).

When operating with electrode polarity negative the "Electrode Sense Polarity" DIP switch must be set to the "Negative" position on the Wire Drive Feed Head PC Board. The default setting of the switch is positive electrode polarity. Consult the Power Feed instruction manual for further details.

VOLTAGE SENSING

The best arc performance occurs when the Power Waves have accurate data about the arc conditions. Depending upon the process, inductance within the electrode and work lead cables can influence the apparent voltage at the studs of the welder. Voltage sense leads improve the accuracy of the arc conditions and can have a dramatic effect on performance. Sense Lead Kits (K940-10, -25 or -50) are available for this purpose.



CAUTION

If the voltage sensing is enabled but the sense leads are missing, improperly connected, or if the electrode polarity switch is improperly configured, extremely high welding outputs may occur.

The ELECTRODE sense lead (67) is built into the control cable, and is automatically enabled for all semi-automatic processes. The WORK sense lead (21) connects to the Power Wave at the four pin connector located underneath the output stud cover. By default the WORK voltage is monitored at the output stud in the Power Wave 455M. For more information on the WORK sense lead (21), see "Work Voltage Sensing" in the following paragraph.

All constant current processes sense the voltage at the output studs of the POWER WAVE-455M by default.

Enable the voltage sense leads as follows:

TABLE A.2

Process	Electrode Voltage Sensing 67 lead *	Work Voltage Sensing 21 lead
GMAW	67 lead required	21 lead optional
GMAW-P	67 lead required	21 lead optional
FCAW	67 lead required	21 lead optional
GTAW	Voltage sense at studs	Voltage sense at studs
GMAW	Voltage sense at studs	Voltage sense at studs
SAW	67 lead required	21 lead optional
CAC	Voltage sense at studs	Voltage sense at studs

* The electrode voltage 67 sense lead is integral to the control cable to the wire feeder.

Work Voltage Sensing

The standard Power Wave 455M's default to the work stud (work sense lead disabled)

For processes requiring work voltage sensing, connect the (21) work voltage sense lead (K940) from the Power Wave work sense lead receptacle to the work piece. Attach the sense lead to the work piece as close to the weld as practical, but not in the return current path. Enable the work voltage sensing in the Power Wave as follows:

WARNING



- Do not touch electrically live parts or electrodes with your skin or wet clothing.
- Insulate yourself from the work and ground.

- Always wear dry insulating gloves.

1. Turn off power to the power source at the disconnect switch.
2. Remove the front cover from the power source.
3. The control board is on the left side of the power source. Locate the 8-position DIP switch and look for switch 8 of the DIP switch.
4. Using a pencil or other small object, slide the switch right to the OFF position if the work sense lead is NOT connected. Conversely, slide the switch to the ON position if the work sense lead is present.
5. Replace the cover and screws. The PC board will "read" the switch at power up, and configure the work voltage sense lead appropriately.

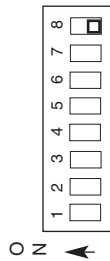

Electrode Voltage Sensing

Enabling or disabling electrode voltage sensing is automatically configured through software. The 67 electrode sense lead is internal to the cable to the wire feeder and always connected when a wire feeder is present.



CAUTION

Important: The electrode polarity must be configured at the feed head for all semi-automatic processes. Failure to do so may result in extremely high welding outputs.

POWER WAVE TO SEMI-AUTOMATIC POWER FEED WIRE FEEDER INTERCONNECTIONS

The Power Wave 455M and semi-automatic POWER FEED family communicate via a 5 conductor control cable (K1543). The control cable consists of two power leads, one twisted pair for digital communication, and one lead for voltage sensing. The cables are designed to be connected end to end for ease of extension. The output receptacle on the Power Wave 455M is located beneath the spring loaded output cover at the bottom of the case front. The input receptacle on the Power Feed is typically located at the back of the feeder, or on the bottom of the user interface.

For convenience sake, the electrode and control cables can be routed behind the left or right strain reliefs (under the spring loaded output cover), and along the channels formed into the base of the Power Wave, out the back of the channels, and then to the wire feeder.

Due to the flexibility of the platform the configuration may vary. The following is a general description of the system.

SYSTEM DESCRIPTION

The Power Wave 455M and Power Feed M family of products utilize a digital communication system called ArcLink. Simply put, ArcLink allows large amounts of information to be passed at very high speeds between components (nodes) in the system. The system requires only two wires for communication, and because of its bus-like structure, the components may be connected to the network in any order, thus simplifying the system setup.

Each "system" must contain only one power source. The number of wire feeders is determined by the type of wire feeder. Refer to the wire feeder instruction manual for details

POWER WAVE 455M



CONFIGURING THE SYSTEM

For codes below 11100, consult the semi-automatic Power Feed instruction manual for configuration information about DIP switch settings.

For codes above 11100, the power source will “Auto Map” the system eliminating most of the need to set DIP switches to configure the system.

If a system can not be “Auto Mapped” then the status light on the power source will blink green fast and the welder output will be disabled. If a system is not “Auto-mappable”, then consult the instruction manual for the accessory being used for configuration information about DIP switch settings, or consult your local Lincoln sales representative.

SINGLE HEAD FEEDER

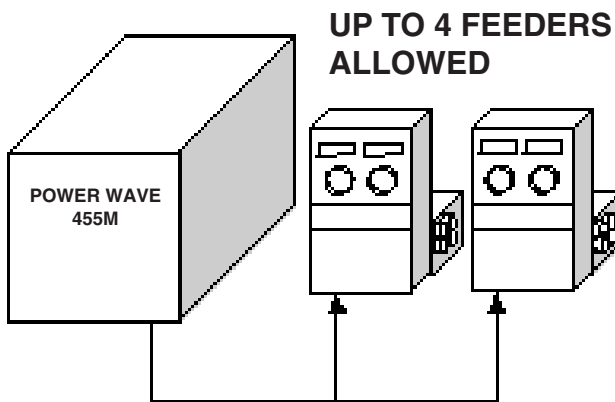

DUAL HEAD FEEDER

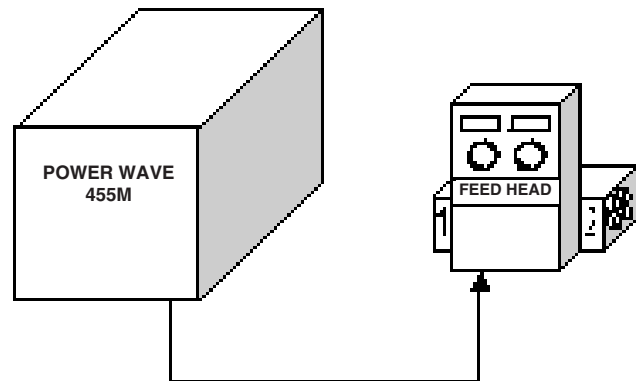

SINGLE HEAD BOOM FEEDER

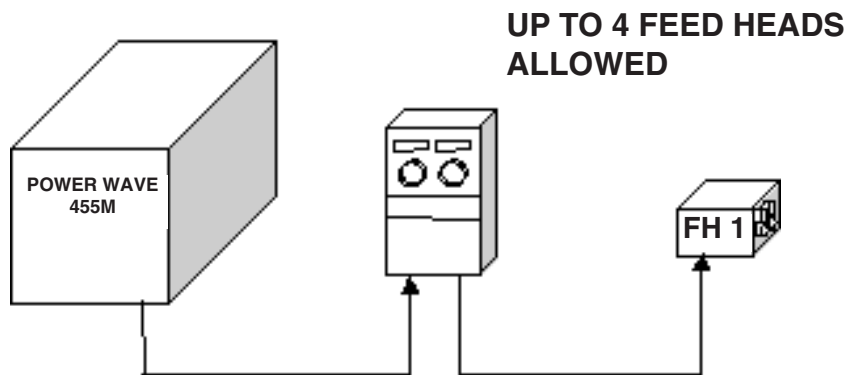

SINGLE HEAD BOOM FEEDER

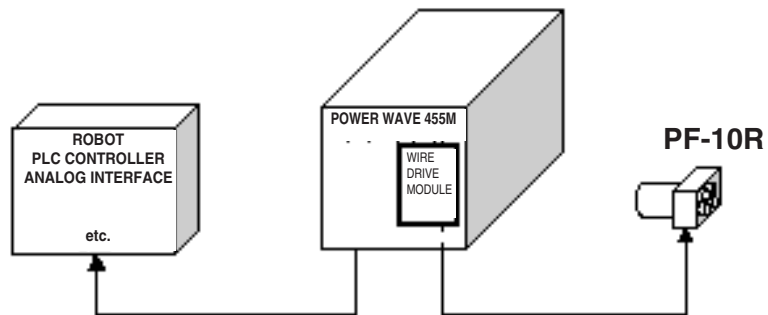

POWER WAVE 455M



ALTERNATE HARD AUTOMATIC APPLICATION (using a UI, WD Module, and PF-10R)

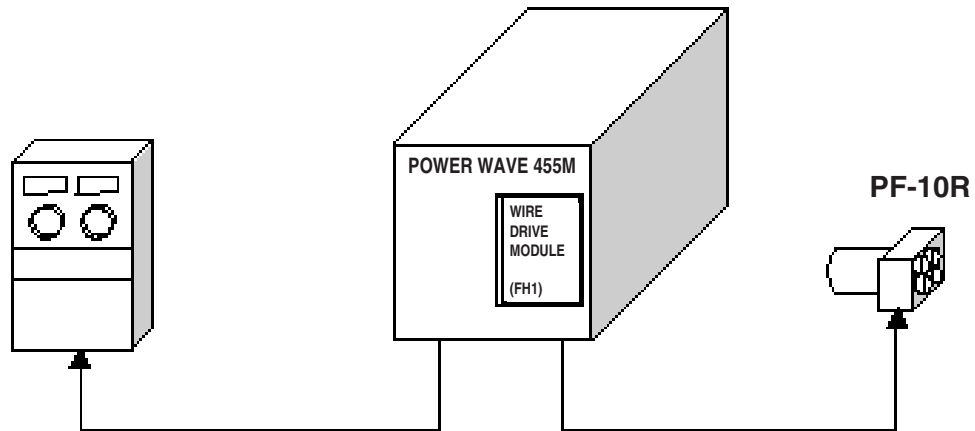

COMBINATION HARD AUTOMATION APPLICATION (w/ Semi-Auto, WD Module, and PF-10R)

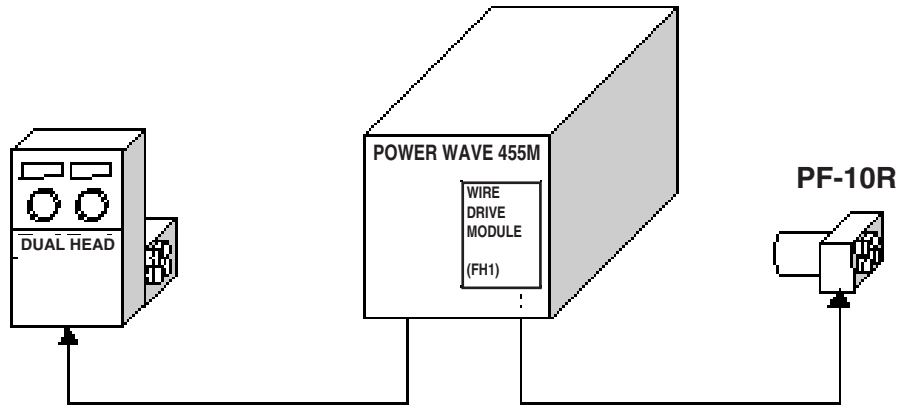

System that is NOT "Auto Mappable"

DUAL HEAD BOOM FEEDER (using two single heads)

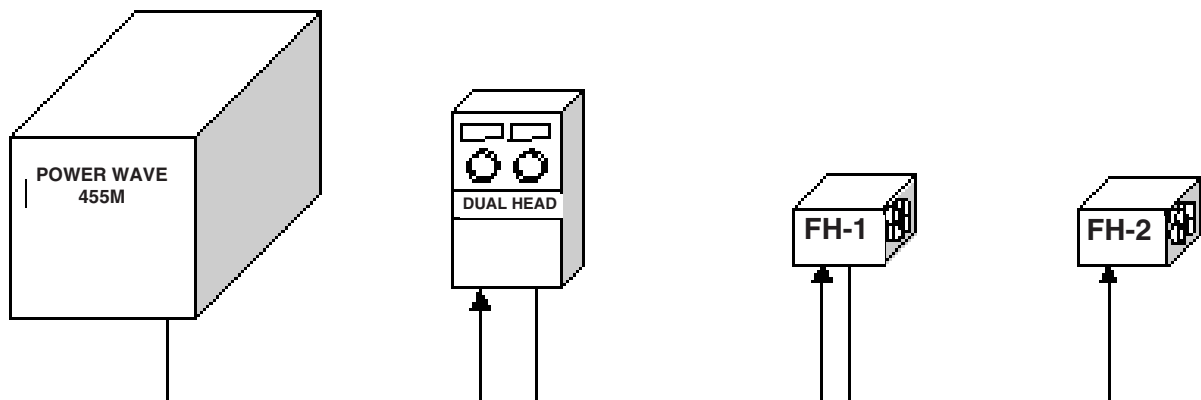

In this case the individual feed heads need to be assigned to the dual head control and the PW455 auto mapping disabled and the Equipment Groups set on (See Figure A-6). (See the Feeder documentation for information on setting the feeder DIP switches)

POWER WAVE 455M



WELDING WITH MULTIPLE POWER WAVES

⚠ CAUTION

Special care must be taken when more than one Power Wave is welding simultaneously on a single part. Arc blow and arc interference may occur or be magnified.

Each power source requires a work lead from the work stud to the welding fixture. Do not combine all of the work leads into one lead. The welding travel directions should be in the direction moving away from the work lead as shown below. Connect all of the work sense leads from each power source to the work piece at the end of the weld.

For the best results when pulse welding, set the wire size and wire feed speed the same for all the Power Waves. When these parameters are identical, the pulsing frequency will be the same, helping to stabilize the arcs.

Every welding gun requires a separate shielding gas regulator for proper flow rate and shielding gas coverage.

Do not attempt to supply shielding gas for two or more guns from only one regulator.

If an anti-spatter system is in use then each gun must have its own anti-spatter system. (See Figure A.2)

CONTROL CABLE SPECIFICATIONS

It is recommended that genuine Lincoln control cables be used at all times. Lincoln cables are specifically designed for the communication and power needs of the Power Wave / Power Feed system.

⚠ CAUTION

The use of non-standard cables, especially in lengths greater than 25 ft.(7.62), can lead to communication problems (system shutdowns), poor motor acceleration (poor arc starting) and low wire driving force (wire feeding problems).

The K1543 series of control cables can be connected end to end for ease of extension. Do not exceed more than 100 feet (30.5 m) total control cable length.

FIGURE A.2

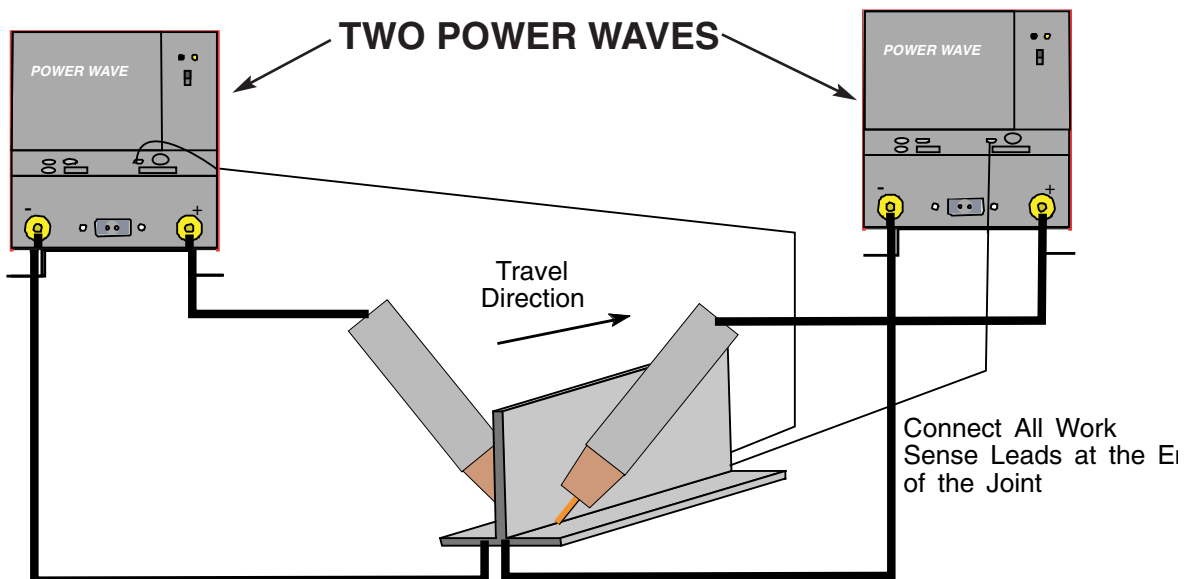

Connect All Welding Work Leads at the Beginning of the Joint

POWER WAVE 455M



MULTIPLE ARC UNSYNCHRONIZED SENSE LEAD AND WORK LEAD PLACEMENT GUIDELINES

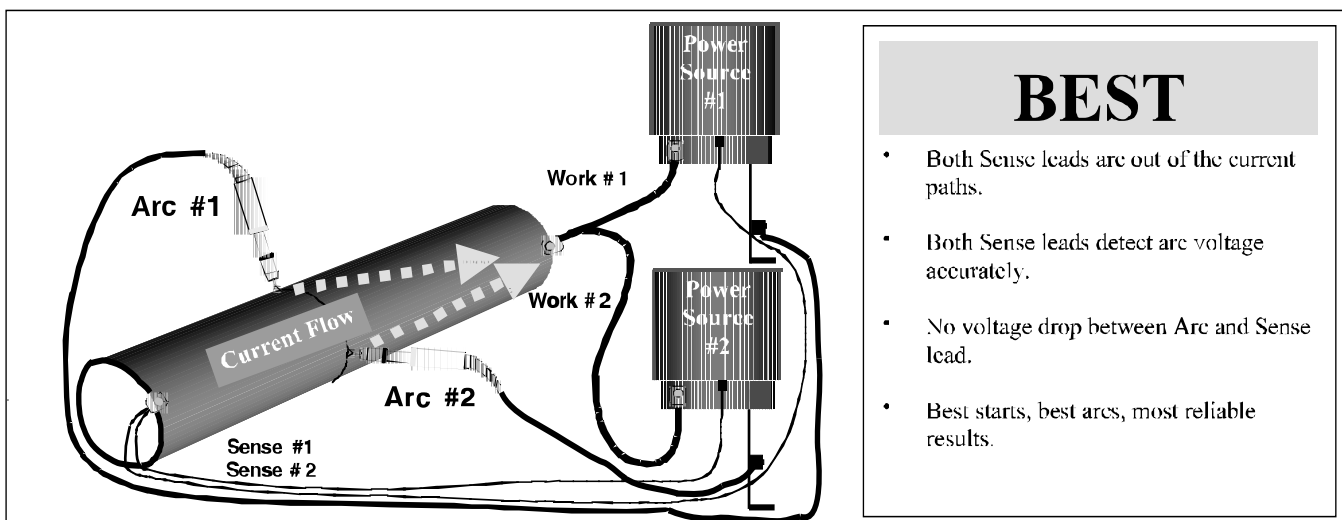
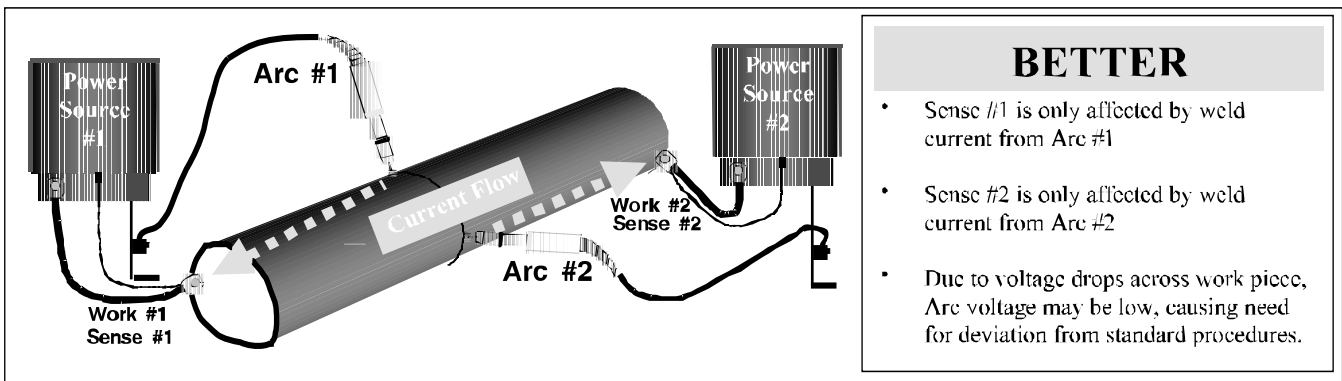
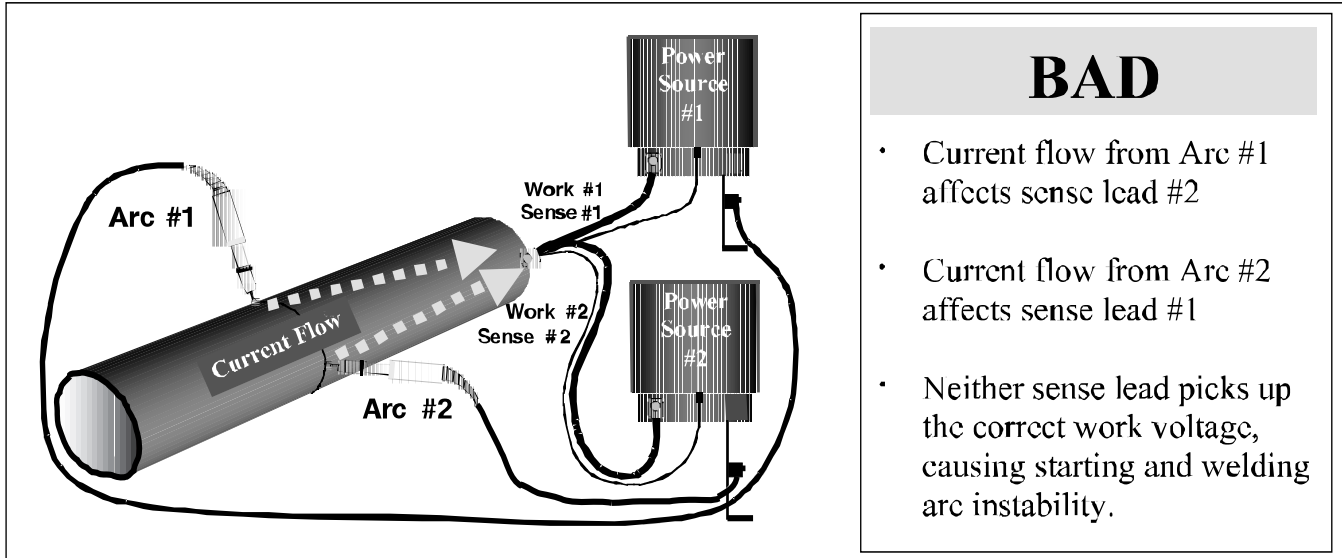

I / O RECEPTACLE SPECIFICATIONS

TABLE 3

WIRE FEEDER RECEPTACLE S1		
PIN	LEAD#	FUNCTION
A	53	Communication Bus L
B	54	Communication Bus H
C	67A	Electrode Voltage Sense
D	52	0vdc
E	51	+40vdc

TABLE 4

VOLTAGE SENSE RECEPTACLE S2		
PIN	LEAD#	FUNCTION
3	21A	Work Voltage Sense

TABLE 5

RS232 RECEPTACLE S3

PIN	LEAD#	FUNCTION
2	253	RS232 Receive
3	254	RS232 Transmit
4	#	S3 Pin5
5	#	S3 Pin4
6	# #	S3 Pin20
20	# #	S3 Pin6
7	251	RS232 Common

switch 7	auto mapping
off(default)	auto mapping enable
on	auto mapping disabled

switch 8	work sense lead
*off(default)	work sense lead not connected
on	work sense lead connected

* The Power Wave 455M does not come supplied with a work sense lead.

FIGURE A.5

CONTROL BOARD (DIP Switch Location)

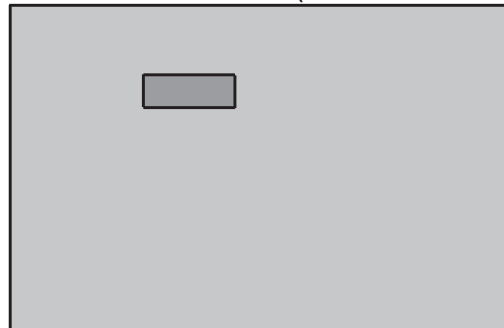

DIP SWITCH SETTINGS AND LOCATIONS

DIP switches on the P.C. Boards allow for custom configuration of the Power Wave. To access the DIP switches:

- Turn off power at the disconnect switch.
- Remove the top four screws securing the front access panel.
- Loosen, but do not completely remove, the bottom two screws holding the access panel.
- Open the access panel, allowing the weight of the panel to be carried by the bottom two screws. Make sure to prevent the weight of the access panel from hanging on the harness.
- Adjust the DIP switches as necessary.
- Replace the panel and screws, and restore power.

CONTROL BOARD DIP SWITCH:

- switch 1 = reserved for future use
- switch 2 = reserved for future use
- switch 3 = equipment group 1 selcted (default=off)
- switch 4 = equipment group 2 selcted (default=off)
- switch 5 = reserved for future use
- switch 6 = reserved for future use
- switch 7 = auto mapping
- switch 8 = work sense lead

(See Figure A.6 for Dual Head Boom Feeder)

WATER FLOW SENSOR

Water cooled guns can be damaged very quickly if they are used even momentarily without water flowing. A water flow sensor is recommended for those water coolers that do not have an integral flow sensor. Recommended practice is to install a water flow sensor such as K1536-1 on the water return line of the torch. When fully integrated into the welding system, the sensor will prevent welding if no water flow is present.

FIGURE A.6

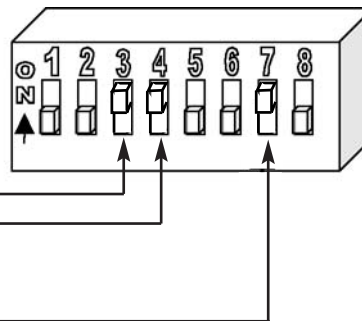

SAFETY PRECAUTIONS

Read this entire section of operating instructions before operating the machine.



WARNING



ELECTRIC SHOCK can kill.

- Unless using cold feed feature, when feeding with gun trigger, the electrode and drive mechanism are always electrically energized and could remain energized several seconds after the welding ceases.
- Do not touch electrically live parts or electrodes with your skin or wet clothing.
- Insulate yourself from the work and ground.
- Always wear dry insulating gloves.



FUMES AND GASES can be dangerous.

- Keep your head out of fumes.
- Use ventilation or exhaust to remove fumes from breathing zone.



WELDING SPARKS can cause fire or explosion.



















- Keep flammable material away.
- Do not weld on containers that have held combustibles.

ARC RAYS can burn.

- Wear eye, ear, and body protection.

Observe additional guidelines detailed in the beginning of this manual.

GRAPHIC SYMBOLS THAT APPEAR ON THIS MACHINE OR IN THIS MANUAL

	INPUT POWER		SMAW
	ON		GMAW
	OFF		FCAW
	HIGH TEMPERATURE		GTAW
	MACHINE STATUS	U_0	OPEN CIRCUIT VOLTAGE
	CIRCUIT BREAKER	U_1	INPUT VOLTAGE
	WIRE FEEDER	U_2	OUTPUT VOLTAGE
	POSITIVE OUTPUT	I_1	INPUT CURRENT
	NEGATIVE OUTPUT	I_2	OUTPUT CURRENT
	3 PHASE INVERTER		PROTECTIVE GROUND
	INPUT POWER		WARNING OR CAUTION
$3 \sim$	THREE PHASE		
	DIRECT CURRENT		

DEFINITION OF WELDING TERMS**NON-SYNERGIC WELDING MODES**

- A **Non-synergic** welding mode requires all welding process variables to be set by the operator.

SYNERGIC WELDING MODES

- A **Synergic** welding mode offers the simplicity of single knob control. The machine will select the correct voltage and amperage based on the wire feed speed (WFS) set by the operator.

455M

- 455Modular

WFS

- Wire Feed Speed

CC

- Constant Current

CV

- Constant Voltage

GMAW

- Gas Metal Arc welding

GMAW-P

- Gas Metal Arc welding-(Pulse Arc)

GMAW-S

- Gas Metal Arc welding-(Short Circuiting Arc)

GTAW

- Gas Tungsten Arc welding

GTAW-P

- Gas Tungsten Arc welding-(Pulse Arc)

PAW

- Plasma Arc welding

SMAW

- Shielded Metal Arc welding

SW

- Stud Arc Welding

SAW

- Submerged Arc Welding

SAW-S

- Submerged Arc Welding-(Series)

FCAW

- Flux Core Arc Welding

CAC

- Carbon Arc Cutting

GENERAL DESCRIPTION

The Power Wave semi-automatic power source is designed to be a part of a modular, multi-process welding system. Depending on configuration, it can support constant current, constant voltage, and pulse welding modes.

The Power Wave power source is designed to be used with the semi automatic family of Power Feed wire feeders, operating as a system. Each component in the system has special circuitry to "talk with" the other system components, so each component (power source, wire feeder, user interface) knows what the other is doing at all times. These components communicate with ArcLink

The Power Wave 455M is a high performance, digitally controlled inverter welding power source capable of complex, high-speed waveform control. Properly equipped, it can support the GMAW, GMAW-P, FCAW, SMAW, GTAW, and CAC processes. It carries an output rating of either 450 amps, 38 volts; or 400 amps, 36 volts (both at 100% duty cycle), depending on input voltage and frequency.

RECOMMENDED PROCESSES AND EQUIPMENT

RECOMMENDED PROCESSES

The Power Wave 455M can be set up in a number of configurations, some requiring optional equipment or welding programs. Each machine is factory preprogrammed with multiple welding procedures, typically including GMAW, GMAW-P, FCAW, GTAW, and CAC for a variety of materials, including mild steel, stainless steel, cored wires, and aluminum.

The Power Wave 455M is recommended for semi-automatic welding with ArcLink compatible equipment like the Power Feed M series of feeders. The Power Wave 455M can have a number of modules installed that allow the machine to be used in Robotic and hard automation applications.

Wire Drive Interface Module

For Robotic platforms the Wire Drive Control Module is required to drive the PF-10R wire drive. This module can be factory installed on K2202-3 or field installed for robotic applications.

The Wire Drive Control Module is also be equipped with a terminal strip for making simple input signal connections. It can be used to externally control the basic wire drive function. It is divided into three groups: Trigger group, Cold Inch group, and Shutdown group.

DeviceNet Interface Module

This module can be used for DeviceNet capability. It will has a 5 pin sealed mini connector per ANSI B93.55M-1981.

EtherNet/DeviceNet Module

This module includes the DeviceNet and EtherNet capability. The DeviceNet uses a 5 pin sealed mini connector per ANSI B93.55M-1981. The EtherNet uses a RJ5 connector.

RECOMMENDED EQUIPMENT

Power Wave 455M – Semi-Automatic Operation

Semi Automatic Power Waves can only be used with ArcLink compatible Power Feed semi-automatic wire feeders and modules. In addition, the Power Feed semi-automatic wire feeders may require optional equipment to access certain weld modes in the Power Wave. Other models of Lincoln feeders, or any models of non-Lincoln wire feeders, cannot be used.

All welding programs and procedures are selected through the Power Feed M semi-automatic user interface

REQUIRED EQUIPMENT

Any ArcLink compatible semi-automatic wire feeding equipment. Specifically, the semi-automatic Power Feed M family.

LIMITATIONS

⚠ WARNING

- **The Power Waves are not to be used in outdoor environments.**
- Only ArcLink compatible Power Feed semi-automatic wire feeders and users interfaces may be used. Other Lincoln wire feeders or non-Lincoln wire feeders cannot be used.
- Power Wave 455M Output Limitations
The Power Wave 455M will support maximum average output current of 570 Amps (@ 60% duty cycle) on the standard Power Wave stud.

DUTY CYCLE AND TIME PERIOD

The Power Feed wire feeders are capable of welding at a 100% duty cycle (continuous welding). The power source will be the limiting factor in determining system duty cycle capability. Note that the duty cycle is based upon a ten minute period. A 60% duty cycle represents 6 minutes of welding and 4 minutes of idling in a ten minute period.

CASE FRONT CONTROLS

All operator controls and adjustments are located on the case front of the Power Wave. (See Figure B.1)

1. POWER SWITCH: Controls input power to the Power Wave.
2. STATUS LIGHT: A two color light that indicates system errors. Normal operation is a steady green light. Error conditions are indicated, per table 3.

NOTE: The Power Wave 455M status light will flash green, and sometimes red and green, for up to one minute when the machine is first turned on. This is a normal situation as the machine goes through a self test at power up.

TABLE 3

Light Condition	Meaning
Steady Green	System OK. Power source communicating normally with wire feeder and its components.
Blinking Green	Occurs during a reset, and indicates the Power Wave 455M is mapping (identifying) each component in the system. Normal for first 1-10 seconds after power is turned on, or if the system configuration is changed during operation
Alternating Green and Red	<p>Non-recoverable system fault. If the PS Status light is flashing any combination of red and green, errors are present in the Power Wave 455M. Read the error code before the machine is turned off.</p> <p>Error Code interpretation through the Status light is detailed in the Service Manual. Individual code digits are flashed in red with a long pause between digits. If more than one code is present, the codes will be separated by a green light.</p> <p>To clear the error, turn power source off, and back on to reset. See Troubleshooting Section.</p>
Steady Red	Non recoverable hardware fault. Generally indicates nothing is connected to the Power Wave 455M wire feeder receptacle. See Trouble Shooting Section.
Blinking Red	Not applicable.

3. HIGH TEMPERATURE LIGHT (thermal overload): A yellow light that comes on when an over temperature situation occurs. Output is disabled and the fan continues to run, until the machine cools down. When cool, the light goes out and output is enabled.
4. 10 AMP WIRE FEEDER CIRCUIT BREAKER: Protects 40 volt DC wire feeder power supply.

FIGURE B.1

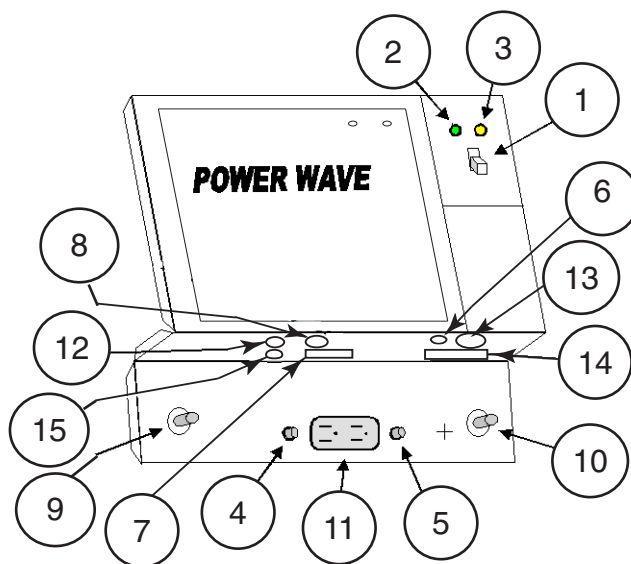

CASE FRONT LAYOUT POWER WAVE 455M (NORTH AMERICAN)

- 15* AMP AUXILIARY POWER CIRCUIT BREAKER: Protects 115 volt AC case front receptacle auxiliary supply.
(* Earlier models used 10 amps circuit breaker).
- LEAD CONNECTOR S2 (SENSE LEAD)
- DIAGNOSTIC CONNECTOR (RS-232)
- WIRE FEEDER RECEPTACLE (S1 5-PIN)
- NEGATIVE STUD
- POSITIVE STUD
- AUXILIARY OUTPUT
- 5-PIN DEVICENET CONNECTOR (OPTIONAL)
- ROBOTIC WIRE FEEDER RECEPTACLE (OPTIONAL)
- I/O CONNECTOR (OPTIONAL)
- ETHERNET CONNECTOR (OPTIONAL)

POWER WAVE 455M



NOMINAL PROCEDURES

The Power Wave is designed to operate with 3/4" electrode stick-out for CV and Pulse processes.

FRINGE PROCEDURES

Excessively short or long electrode stick-outs may function only on a limited basis, if at all.

MAKING A WELD

WARNING

The serviceability of a product or structure utilizing the welding programs is and must be the sole responsibility of the builder/user. Many variables beyond the control of The Lincoln Electric Company affect the results obtained in applying these programs. These variables include, but are not limited to, welding procedure, plate chemistry and temperature, weldment design, fabrication methods and service requirements. The available range of a welding program may not be suitable for all applications, and the build/user is and must be solely responsible for welding program selection.

The steps for operating the Power Wave will vary depending upon the options installed in the user interface (control box) of the welding system. The flexibility of the Power Wave system lets the user customize operation for the best performance.

First, consider the desired welding process and the part to be welded. Choose an electrode material, diameter, shielding gas and process (GMAW, GMAW-P, etc.)

Second, find the program in the welding software that best matches the desired welding process. The standard software shipped with the Power Waves encompasses a wide range of common processes and will meet most needs. If a special welding program is desired, contact the local Lincoln Electric sales representative.

To make a weld, the Power Wave needs to know the desired welding parameters. The Power Feed (PF) family of feeders communicate settings to the Power Wave through control cable connection. Arc length, wire feed speed, arc control, etc. are all communicated digitally via the control cable.

WELDING ADJUSTMENTS

All adjustments are made on the system component known as the User Interface (Control Box), which contains the switches, knobs, and digital displays necessary to control both the Power Wave and a Power Feed wire feeder. Typically, the Control Box is supplied as part of the wire feeder. It can be mounted directly on the wire feeder itself, the front of the power source, or mounted separately, as might be done in a welding boom installation.

Because the Control Box can be configured with many different options, your system may not have all of the following adjustments. Regardless of availability, all controls are described below. For further information, consult the Power Feed wire feeder instruction manual.

• WFS / AMPS:

In synergic welding modes (synergic CV, pulse GMAW) WFS (wire feed speed) is the dominant control parameter, controlling all other variables. The user adjusts WFS according to factors such as weld size, penetration requirements, heat input, etc. The Power Wave then uses the WFS setting to adjust its output characteristics (output voltage, output current) according to pre-programmed settings contained in the Power Wave 455M. In non-synergic modes, the WFS control behaves more like a conventional CV power source where WFS and voltage are independent adjustments. Therefore to maintain the arc characteristics, the operator must adjust the voltage to compensate for any changes made to the WFS.

In constant current modes (stick, TIG) this control adjusts the output current, in amps.

• VOLTS / TRIM:

In constant voltage modes (synergic CV, standard CV) the control adjusts the welding voltage.

In pulse synergic welding modes (pulse GMAW only) the user can change the Trim setting to adjust the arc length. It is adjustable from 0.500 to 1.500. A Trim setting of 1.000 is a good starting point for most conditions.

• WELDING MODE

May be selected by name (CV/MIG, CC/Stick Crisp, Gouge, etc.) or by a mode number (10, 24, 71, etc.) depending on the Control Box options. Selecting a welding mode determines the output characteristics of the Power Wave power source. For a more complete description of the welding modes available in the Power Wave, see the explanation below.

• ARC CONTROL

Also known as Inductance or Wave Control. Allows operator to vary the arc characteristics from "soft" to "harsh" in all weld modes. It is adjustable from -10.0 to +10.0, with a nominal setting of 00.0 (The nominal setting of 00.0 may be displayed as OFF on some Power Feed wire feeder control panels). See the Welding Mode descriptions, below, for detailed explanations of how the Arc Control affects each mode.

CONSTANT VOLTAGE WELDING

Synergic CV:

For each wire feed speed, a corresponding voltage is preprogrammed into the machine through special software at the factory. The nominal preprogrammed voltage is the best average voltage for a given wire feed speed, but may be adjusted to preference. When the wire feed speed changes, the Power Wave automatically adjusts the voltage level correspondingly to maintain similar arc characteristics throughout the WFS range.

Non Synergic CV:

This type of CV mode behaves more like a conventional CV power source. Voltage and WFS are independent adjustments. Therefore to maintain the arc characteristics, the operator must adjust the voltage to compensate for any changes made to the WFS.

All CV Modes:

Arc Control, often referred to as wave control, adjusts the inductance of the wave shape. The wave control adjustment is similar to the "pinch" function in that it is inversely proportional to inductance. Therefore, increasing wave control greater than 0.0 results in a harsher, colder arc while decreasing the wave control to less than 0.0 provides a softer, hotter arc. (See Figure A.5)

FIGURE A.5
CURRENT WAVE FORM (CV)

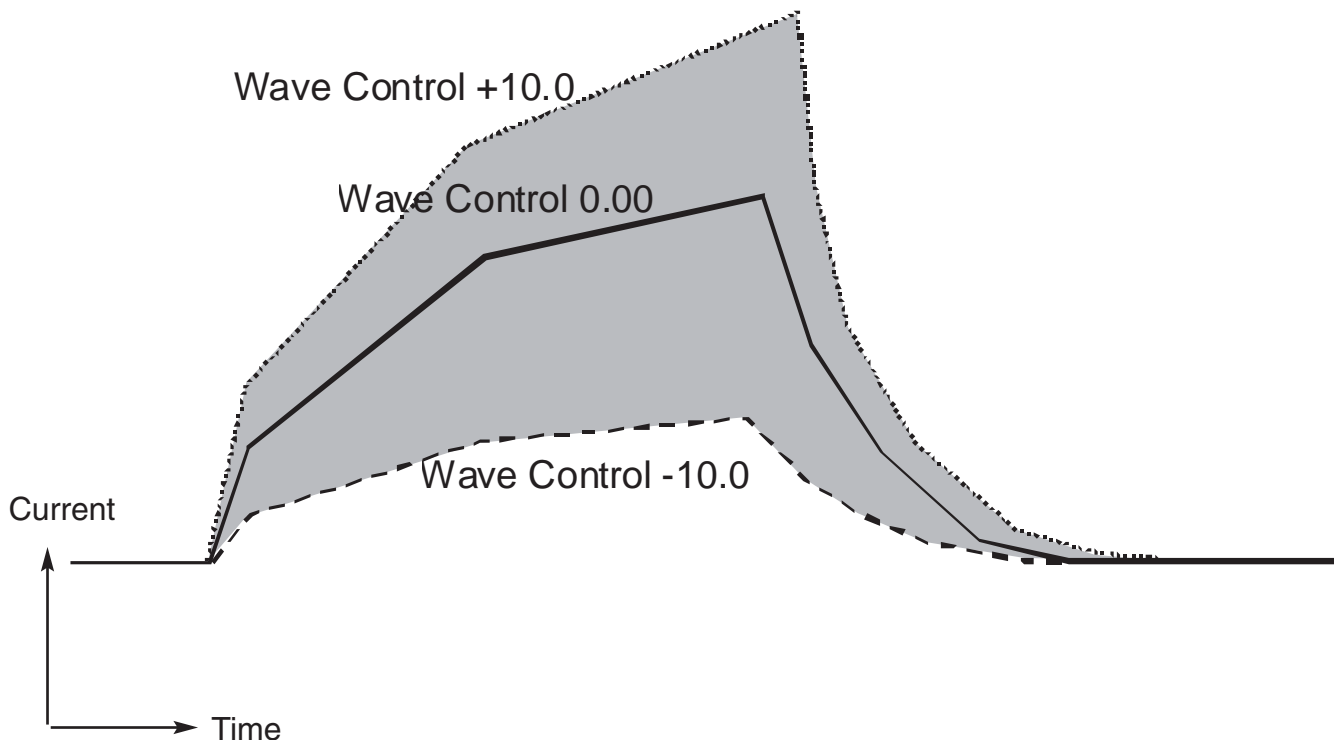

POWER WAVE 455M



PULSE WELDING

Pulse welding procedures are set by controlling an overall "arc length" variable. When pulse welding, the arc voltage is highly dependent upon the waveform. The peak current, back ground current, rise time, fall time and pulse frequency all affect the voltage. The exact voltage for a given wire feed speed can only be predicted when all the pulsing waveform parameters are known. Using a preset voltage becomes impractical, and instead the arc length is set by adjusting "trim".

Trim adjusts the arc length and ranges from 0.50 to 1.50, with a nominal value of 1.00. Trim values greater than 1.00 increase the arc length, while values less than 1.00 decrease the arc length.

Most pulse welding programs are synergic. As the wire feed speed is adjusted, the Power Wave will automatically recalculate the waveform parameters to maintain similar arc properties.

The Power Wave utilizes "adaptive control" to compensate for changes in electrical stick-out while welding. (Electrical stick-out is the distance from the contact tip to the work piece.) The Power Wave waveforms are optimized for a 0.75" (19mm) stick-out. The adaptive behavior supports a range of stickouts from 0.50" (13mm) to 1.25" (32mm). At very low or high wire feed speeds, the adaptive range may be less due to reaching physical limitations of the welding process.

Arc Control, often referred to as wave control, in pulse programs usually adjusts the focus or shape of the arc. Wave control values greater than 0.0 increase the pulse frequency while decreasing the background current, resulting in a tight, stiff arc best for high speed sheet metal welding. Wave control values less than 0.0 decrease the pulse frequency while increasing the background current, for a soft arc good for out-of-position welding.

(See Figure A.6)

FIGURE A.6
CURRENT WAVE FORM (PULSE)

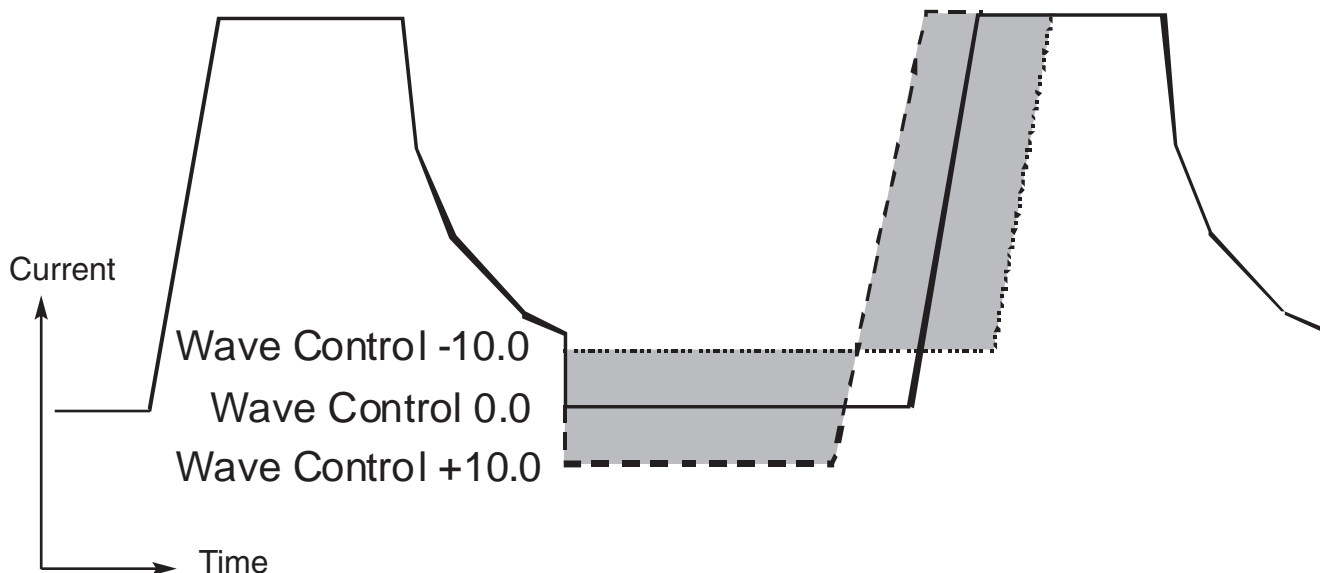

FACTORY INSTALLED

Wire Drive Interface Module, K2205-1

FIELD INSTALLED

Work Voltage Sense Lead Kit, K940
Dual Cylinder Undercarriage, K1570-1.
Gas Guard Regulator, K659-1
Coaxial welding Cable, K1796
Cool Arc 40 K1813-1 (115VAC)
Water Flow Sensor, K1536-1
Wire Drive Interface Module, K2205-1
DeviceNet interface Module, K2206-1

COMPATIBLE LINCOLN EQUIPMENT

Any Arc-Link compatible semi-automatic wire feeding equipment. Specifically, the semi-automatic Power Feed M family. If the wire drive interface module is installed the machine is compatible with the Power Feed 10R wire feeder.

SAFETY PRECAUTIONS

WARNING

ELECTRIC SHOCK can kill.



- Only Qualified personnel should perform this maintenance.
- Turn the input power OFF at the disconnect switch or fuse box before working on this equipment.
- Do not touch electrically hot parts.

ROUTINE MAINTENANCE

Routine maintenance consists of periodically blowing out the machine, using a low pressure airstream, to remove accumulated dust and dirt from the intake and outlet louvers, and the cooling channels in the machine.

PERIODIC MAINTENANCE

Calibration of the Power Wave 455M is critical to its operation. Generally speaking the calibration will not need adjustment. However, neglected or improperly calibrated machines may not yield satisfactory weld performance. To ensure optimal performance, the calibration of output Voltage and Current should be checked yearly.

CALIBRATION SPECIFICATION

Output Voltage and Current are calibrated at the factory. Generally speaking the machine calibration will not need adjustment. However, if the weld performance changes, or the yearly calibration check reveals a problem, contact the Lincoln Electric Company for the calibration software utility.

The calibration procedure itself requires the use of a grid, and certified actual meters for voltage and current. The accuracy of the calibration will be directly affected by the accuracy of the measuring equipment you use. Detailed instructions are available with the utility.

HOW TO USE TROUBLESHOOTING GUIDE**⚠ WARNING**

Service and Repair should only be performed by Lincoln Electric Factory Trained Personnel. Unauthorized repairs performed on this equipment may result in danger to the technician and machine operator and will invalidate your factory warranty. For your safety and to avoid Electrical Shock, please observe all safety notes and precautions detailed throughout this manual.

This Troubleshooting Guide is provided to help you locate and repair possible machine malfunctions. Simply follow the three-step procedure listed below.

Step 1. LOCATE PROBLEM (SYMPTOM).

Look under the column labeled "PROBLEM (SYMPTOMS)". This column describes possible symptoms that the machine may exhibit. Find the listing that best describes the symptom that the machine is exhibiting.

Step 2. POSSIBLE CAUSE.

The second column labeled "POSSIBLE CAUSE" lists the obvious external possibilities that may contribute to the machine symptom.

Step 3. RECOMMENDED COURSE OF ACTION

This column provides a course of action for the Possible Cause, generally it states to contact your local Lincoln Authorized Field Service Facility.

If you do not understand or are unable to perform the Recommended Course of Action safely, contact your local Lincoln Authorized Field Service Facility.

⚠ CAUTION

If for any reason you do not understand the test procedures or are unable to perform the tests/repairs safely, contact your **Local Lincoln Authorized Field Service Facility** for technical troubleshooting assistance before you proceed.

USING THE STATUS LED TO TROUBLESHOOT SYSTEM PROBLEMS

The Power Wave / Power Feed are best diagnosed as a system. Each component (power source, user interface, and feed head) has a status light, and when a problem occurs it is important to note the condition of each. In addition, errors displayed on the user interface in most cases indicate only that a problem exists in the power source, not what the problem may be. **Therefore, prior to cycling power to the system, check the power source status light for error sequences as noted below. This is especially important if the user interface displays "Err 006" or "Err 100" .**

Included in this section is information about the power source Status LED, and some basic troubleshooting

charts for both machine and weld performance. The STATUS LIGHT is a two color light that indicates system errors. Normal operation is a steady green light. Error conditions are indicated in the following chart.

NOTE: The Power Wave 455M status light will flash green, and sometimes red and green, for up to one minute when the machine is first turned on. This is a normal situation as the machine goes through a self test at power up.

LIGHT CONDITION	MEANING
Status LED is solid green (no blinking).	1. System OK. Power source communicating normally with wire feeder and its components.
Status LED is blinking green.	2. Occurs during a reset, and indicates the Power Wave 455M is mapping (identifying) each component in the system. Normal for first 1-10 seconds after power is turned on, or if the system configuration is changed during operation.
Status LED is blinking red and green.	3. Non-recoverable system fault. If the PS Status light is flashing any combination of red and green, errors are present in the Power Wave 455M. Read the error code before the machine is turned off. Error Code interpretation through the Status light is detailed in the Service Manual. Individual code digits are flashed in red with a long pause between digits. If more than one code is present, the codes will be separated by a green light. To clear the error, turn power source off, and back on to reset.
Status LED is solid red (no blinking).	Non recoverable hardware fault. Generally indicates nothing is connected to the Power Wave 455M wire feeder receptacle. See Trouble Shooting Section.
Status LED is blinking red.	Not applicable.

Observe all Safety Guidelines detailed throughout this manual

ERROR CODES FOR THE POWERWAVE

The following is a list of possible error codes that the Power Wave 455M can output via the status light (see "Troubleshooting the Power Wave / Power Feed System Using the Status LED." If connected to a PF-10/11 these error codes will generally be accompanied by an "Err 006" or "Err 100" on the user interface display.

Error Code #	Indication
11 CAN communication bus off.	Probably due to excessive number of communication errors.
12 User Interface time out error.	UI is no longer responding to the Power Source. The most likely cause is a fault/bad connection in the communication leads or control cable.
21 Unprogrammed Weld Mode.	Contact the Service Department for instructions on reloading the Welding Software.
22 Empty Weld Table.	Contact the Service Department for instructions on reloading the Welding Software.
23 Weld Table checksum error.	Contact the Service Department for instructions on reloading the Welding Software.
31 Primary overcurrent error.	Excessive Primary current present. May be related to a short in the main transformer or output rectifier.
32 Capacitor "A" under voltage (Left side facing machine)	Low voltage on the main capacitors. May be caused by improper input configuration.
33 Capacitor "B" under voltage (Right side facing machine)	When accompanied by an overvoltage error on the same side, it indicates no capacitor voltage present on that side, and is usually the result of an open or short in the primary side of the machine.
34 Capacitor "A" over voltage (Left side facing machine)	Excess voltage on the main capacitors. May be caused by improper input configuration.
35 Capacitor "B" over voltage (Right side facing machine)	When accompanied by an under voltage error on the same side, it indicates no capacitor voltage present on that side, and is usually the result of an open or short in the primary side of the machine.
36 Thermal error	Indicates over temperature. Usually accompanied by Thermal LED. Check fan operation. Be sure process does not exceed duty cycle limit of the machine.
37 Soft start error	Capacitor precharge failed. Usually accompanied by codes 32-35.
41 Secondary overcurrent error	The secondary (weld) current limit has been exceeded. When this occurs the machine output will phase back to 100 amps, typically resulting in a condition referred to as "noodle welding" NOTE: The secondary limit is 570 amps for the standard stud, and 325 amps for all single phase operation.
43 Capacitor delta error	The maximum voltage difference between the main capacitors has been exceeded. May be accompanied by errors 32-35.
49 Single phase error	Indicates machine is running on single phase input power. Usually caused by the loss of the middle leg (L2).
Other	Error codes that contain three or four digits are defined as fatal errors. These codes generally indicate internal errors on the PS Control Board. If cycling the input power on the machine does not clear the error, try reloading the operating system. If this fails, replace the control board.

CAUTION

If for any reason you do not understand the test procedures or are unable to perform the tests/repairs safely, contact your **Local Lincoln Authorized Field Service Facility** for technical troubleshooting assistance before you proceed.

POWER WAVE 455M



Observe all Safety Guidelines detailed throughout this manual

PROBLEMS (SYMPTOMS)	POSSIBLE CAUSE	RECOMMENDED COURSE OF ACTION
OUTPUT PROBLEMS		
Major physical or electrical damage is evident when the sheet metal covers are removed.	1. Contact your local authorized Lincoln Electric Field Service facility for technical assistance.	<p>If all recommended possible areas of misadjustments have been checked and the problem persists, contact your local Lincoln Authorized Field Service Facility.</p>
Input fuses keep blowing, or input breaker keeps tripping.	<ol style="list-style-type: none"> 1. Make certain that fuses or breakers are properly sized. See Installation section of this manual for recommended fuse and breaker sizes. 2. Welding procedure is drawing too much output current, or duty cycle is too high. Reduce output current, duty cycle, or both. 3. There is internal damage to the power source. Contact an authorized Lincoln Electric Service facility. 	
Machine will not power up (no lights, no fan, etc.)	<ol style="list-style-type: none"> 1. Make certain that the Power Switch (SW1) is in the "ON" position. 2. Circuit breaker CB4 (in reconnect area) may have opened. Reset. Also, check input voltage selection, below. 3. Input voltage selection made improperly. Power down, check input voltage reconnect according to diagram on reconnect cover. 	
Thermal LED is lit.	<ol style="list-style-type: none"> 1. Fan thermostat has opened. Check for proper fan operation. (Fan should run whenever output power is on.) Check for material blocking intake or exhaust louvers, or for excessive dirt clogging cooling channels in machine. 2. Secondary rectifier or Choke thermostat has opened. After machine has cooled, reduce load, duty cycle, or both. Check for material blocking intake or exhaust louvers. 3. DC Bus PC board thermostat has opened check for excessive load on 40VDC supply. 	



CAUTION

If for any reason you do not understand the test procedures or are unable to perform the tests/repairs safely, contact your local authorized Lincoln Electric Field Service Facility for technical assistance.

POWER WAVE 455M



Observe all Safety Guidelines detailed throughout this manual

PROBLEMS (SYMPTOMS)	POSSIBLE CAUSE	RECOMMENDED COURSE OF ACTION
OUTPUT PROBLEMS		
Machine won't weld, can't get any output. (CR1 will not pull in.)	<ol style="list-style-type: none"> 1. Input voltage is too low or too high. Make certain that input voltage is proper, according to the Rating Plate located on the rear of the machine. 2. If the Thermal LED is also lit, see "Yellow Thermal LED is Lit" section. 3. Primary current limit has been exceeded. Possible short in output circuit. Turn machine off. Remove all loads from the output of the machine. Turn back on. If condition persists, turn power off, and contact an authorized Lincoln Electric Field Service facility. 4. This problem will normally be accompanied by an error code. Error codes are displayed as a series of red and green flashes by the status light. See "Troubleshooting the Power Wave / Power Feed System Using the Status LED" section of this text. 	<p>If all recommended possible areas of misadjustments have been checked and the problem persists, contact your local Lincoln Authorized Field Service Facility.</p>
Machine often "noodle welds" (output is limited to approximately 100 amps) when running a particular procedure, especially a procedure with high WFS.	<ol style="list-style-type: none"> 1. Secondary current limit has been exceeded, and the machine has phased back to protect itself. 2. Adjust procedure or reduce load to lower current draw from the machine. 3. A single phase input (loss of L2) will reduce the secondary current limit from 570 Amps to 325 Amps. 	



CAUTION

If for any reason you do not understand the test procedures or are unable to perform the tests/repairs safely, contact your local authorized Lincoln Electric Field Service Facility for technical assistance.

POWER WAVE 455M



Observe all Safety Guidelines detailed throughout this manual

PROBLEMS (SYMPTOMS)	POSSIBLE CAUSE	RECOMMENDED COURSE OF ACTION
OUTPUT PROBLEMS		
Machine won't produce full output.	<ol style="list-style-type: none"> 1. Input voltage may be too low, limiting output capability of the power source. Make certain that the input voltage is proper, according to the Rating Plate located on the rear of the machine. 2. Input may be "single phased". Make certain the input voltage is proper on all three Input lines. 3. Secondary current or voltage not be properly calibrated. Check values displayed on the Power Feed 10/11 verses readings on an external meter. 	<p>If all recommended possible areas of misadjustments have been checked and the problem persists, contact your local Lincoln Authorized Field Service Facility.</p>
Auxiliary receptacle is "dead" no auxiliary voltage .	<ol style="list-style-type: none"> 1. Circuit breaker CB2 (on case front) may have opened. Reset. 2. Circuit breaker CB4 (in reconnect area) may have opened. Reset. 	
General degradation of the weld performance	<ol style="list-style-type: none"> 1. Check for feeding problems, bad connections, excessive loops in cabling, etc. 2. Verify weld mode is correct for processes. 3. The power source may require calibration. 4. Check the actual current displayed on the Power Feed 10 vs. actual current measured via external meter. 5. Check the actual voltage displayed on the Power Feed 10 vs. actual voltage measured via external meter. 6. Check the actual WFS displayed on the Power Feed 10 vs. actual WFS measured via external meter. 	
Excessively long and erratic arc.	<ol style="list-style-type: none"> 1. Check for proper configuration and implementation of voltage sensing circuits. 	



CAUTION

If for any reason you do not understand the test procedures or are unable to perform the tests/repairs safely, contact your local authorized Lincoln Electric Field Service Facility for technical assistance.

POWER WAVE 455M



POWER WAVE™ 455M WIRING DIAGRAM FOR CODE 10942

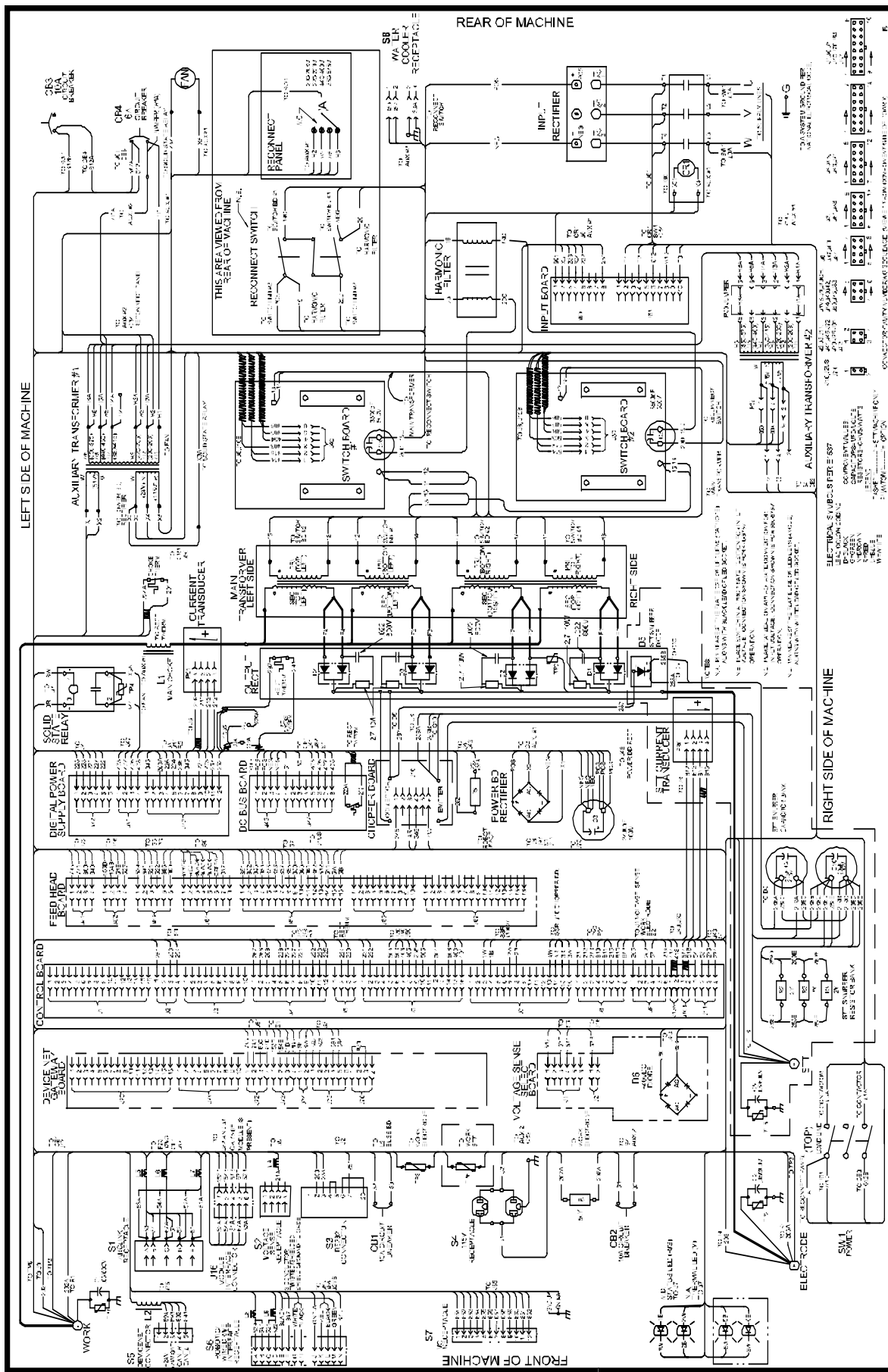

G4212

NOTE: This diagram is for reference only. It may not be accurate for all machines covered by this manual. The specific diagram for a particular code is pasted inside the machine on one of the enclosure panels. If the diagram is illegible, write to the Service Department for a replacement. Give the equipment code number.

POWER WAVE 455M



POWER WAVE™ 455M WIRING DIAGRAM FOR CODES 11057, 11152, 11311

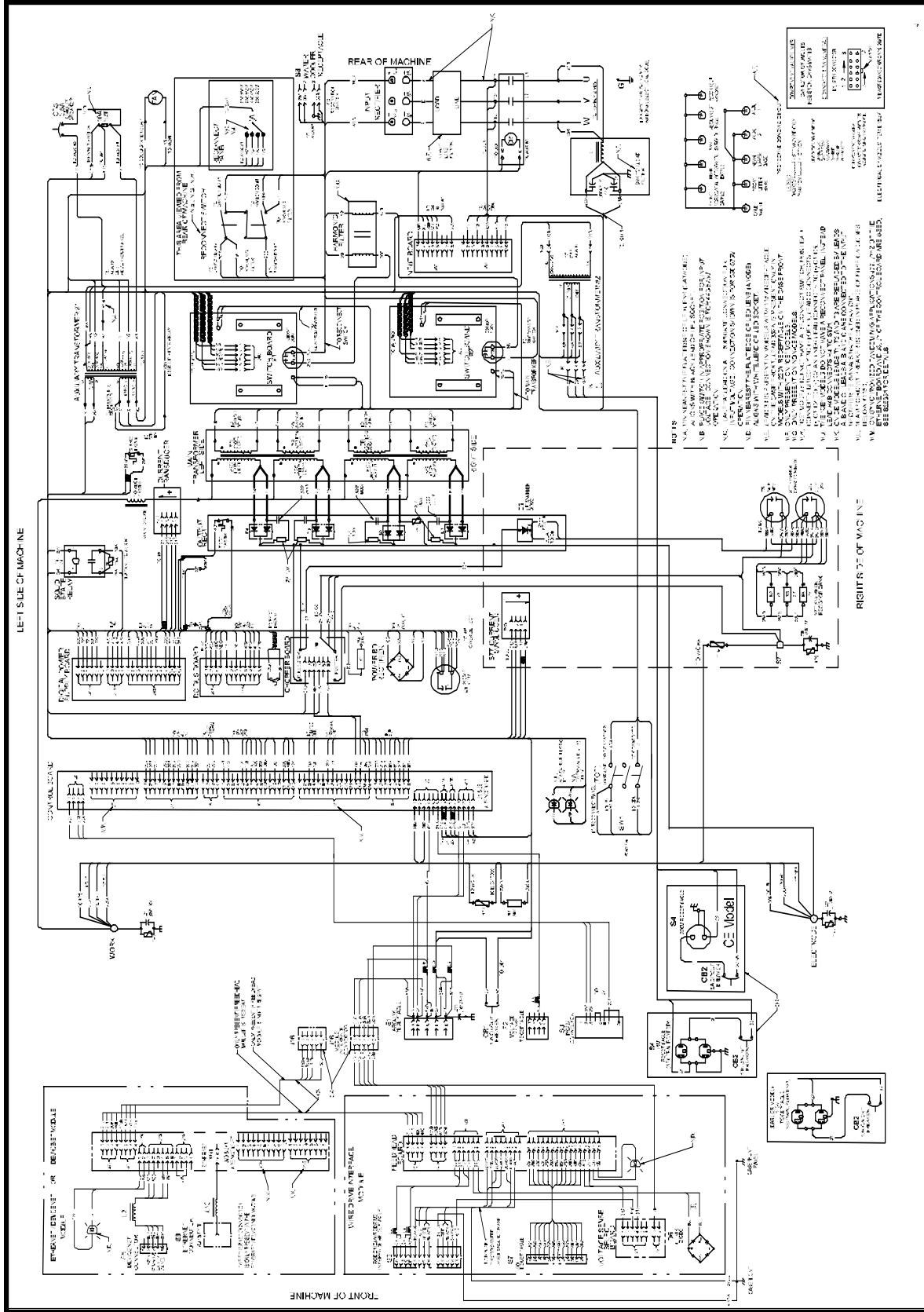

G4420

NOTE: This diagram is for reference only. It may not be accurate for all machines covered by this manual. The specific diagram for a particular code is pasted inside the machine on one of the enclosure panels. If the diagram is illegible, write to the Service Department for a replacement. Give the equipment code number.

Connection Diagram Semi-automatic "Simple System"
(Electrode Positive, CV/Pulse Configuration shown)

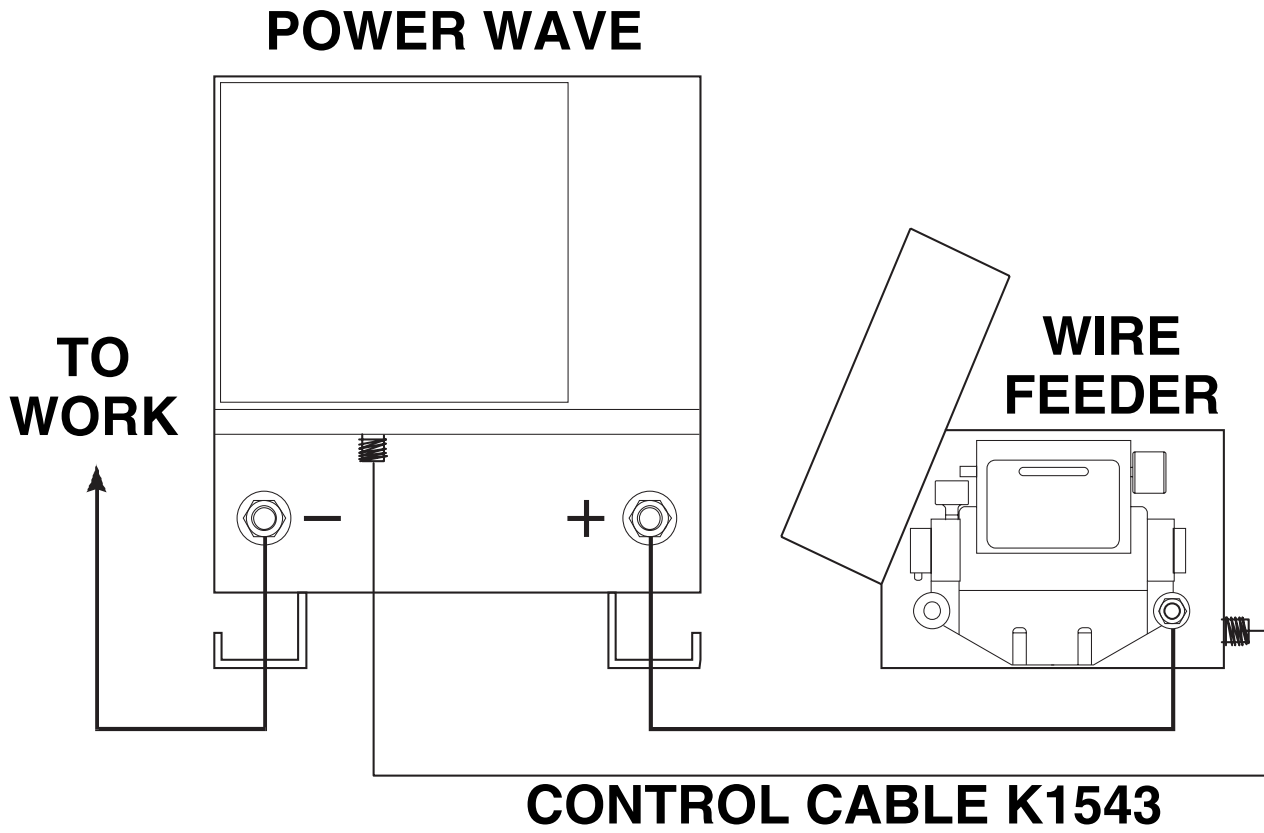

POWER WAVE 455M



DIMENSION PRINT - POWER WAVE 455M

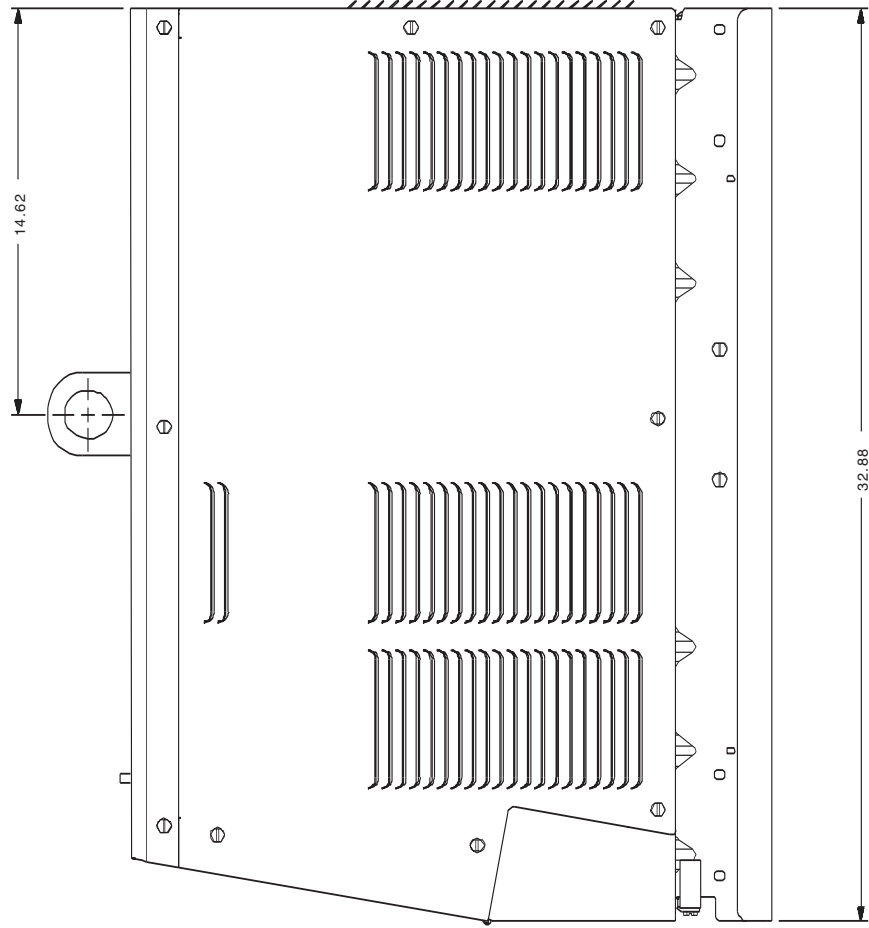
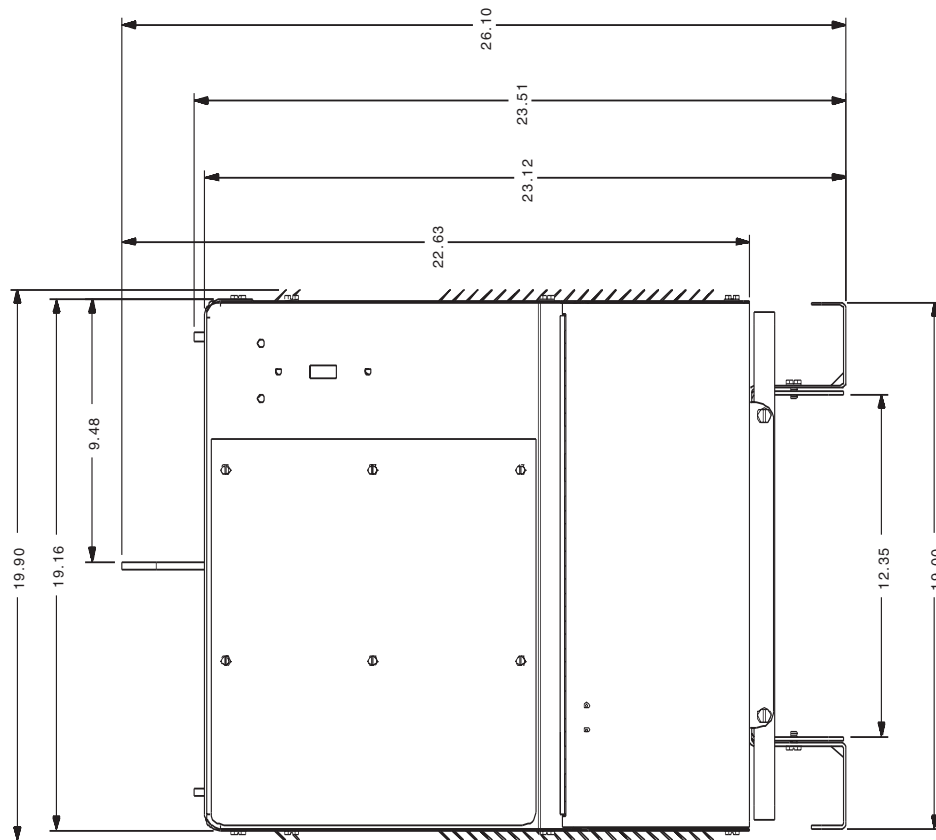

11-14-97
M18241

POWER WAVE 455M



NOTES

POWER WAVE 455M



WARNING	<ul style="list-style-type: none"> ● Do not touch electrically live parts or electrode with skin or wet clothing. ● Insulate yourself from work and ground. 	<ul style="list-style-type: none"> ● Keep flammable materials away. 	<ul style="list-style-type: none"> ● Wear eye, ear and body protection.
Spanish AVISO DE PRECAUCION	<ul style="list-style-type: none"> ● No toque las partes o los electrodos bajo carga con la piel o ropa mojada. ● Aíslese del trabajo y de la tierra. 	<ul style="list-style-type: none"> ● Mantenga el material combustible fuera del área de trabajo. 	<ul style="list-style-type: none"> ● Protéjase los ojos, los oídos y el cuerpo.
French ATTENTION	<ul style="list-style-type: none"> ● Ne laissez ni la peau ni des vêtements mouillés entrer en contact avec des pièces sous tension. ● Isolez-vous du travail et de la terre. 	<ul style="list-style-type: none"> ● Gardez à l'écart de tout matériel inflammable. 	<ul style="list-style-type: none"> ● Protégez vos yeux, vos oreilles et votre corps.
German WARNUNG	<ul style="list-style-type: none"> ● Berühren Sie keine stromführenden Teile oder Elektroden mit Ihrem Körper oder feuchter Kleidung! ● Isolieren Sie sich von den Elektroden und dem Erdboden! 	<ul style="list-style-type: none"> ● Entfernen Sie brennbares Material! 	<ul style="list-style-type: none"> ● Tragen Sie Augen-, Ohren- und Körperschutz!
Portuguese ATENÇÃO	<ul style="list-style-type: none"> ● Não toque partes elétricas e electrodos com a pele ou roupa molhada. ● Isole-se da peça e terra. 	<ul style="list-style-type: none"> ● Mantenha inflamáveis bem guardados. 	<ul style="list-style-type: none"> ● Use proteção para a vista, ouvido e corpo.
Japanese 注意事項	<ul style="list-style-type: none"> ● 通電中の電気部品、又は溶材にヒフやぬれた布で触れないこと。 ● 施工物やアースから身体が絶縁されている様にして下さい。 	<ul style="list-style-type: none"> ● 燃えやすいものの側での溶接作業は絶対にしてはなりません。 	<ul style="list-style-type: none"> ● 目、耳及び身体に保護具をして下さい。
Chinese 警告	<ul style="list-style-type: none"> ● 皮肤或湿衣物切勿接触带电部件及焊条。 ● 使你自已与地面和工件绝缘。 	<ul style="list-style-type: none"> ● 把一切易燃物品移离工作场所。 	<ul style="list-style-type: none"> ● 佩戴眼、耳及身体劳动保护用具。
Korean 위험	<ul style="list-style-type: none"> ● 전도체나 용접봉을 젖은 형갑 또는 피부로 절대 접촉치 마십시오. ● 모재와 접지를 접촉치 마십시오. 	<ul style="list-style-type: none"> ● 인화성 물질을 접근시키지 마십시오. 	<ul style="list-style-type: none"> ● 눈, 귀와 몸에 보호장구를 착용하십시오.
Arabic تحذير	<ul style="list-style-type: none"> ● لا تلمس الاجزاء التي يسري فيها التيار الكهربائي أو الألكترود بجلد الجسم أو بالملابس المبللة بالماء. ● ضع عازلا على جسمك خلال العمل. 	<ul style="list-style-type: none"> ● ضع المواد القابلة للاشتعال في مكان بعيد. 	<ul style="list-style-type: none"> ● ضع أدوات وملابس واقية على عينيك وأذنيك وجسمك.

READ AND UNDERSTAND THE MANUFACTURER'S INSTRUCTION FOR THIS EQUIPMENT AND THE CONSUMABLES TO BE USED AND FOLLOW YOUR EMPLOYER'S SAFETY PRACTICES.

SE RECOMIENDA LEER Y ENTENDER LAS INSTRUCCIONES DEL FABRICANTE PARA EL USO DE ESTE EQUIPO Y LOS CONSUMIBLES QUE VA A UTILIZAR, SIGA LAS MEDIDAS DE SEGURIDAD DE SU SUPERVISOR.

LISEZ ET COMPRENEZ LES INSTRUCTIONS DU FABRICANT EN CE QUI REGARDE CET EQUIPMENT ET LES PRODUITS A ETRE EMPLOYES ET SUIVEZ LES PROCEDURES DE SECURITE DE VOTRE EMPLOYEUR.

LESEN SIE UND BEFOLGEN SIE DIE BETRIEBSANLEITUNG DER ANLAGE UND DEN ELEKTRODENEINSATZ DES HERSTELLERS. DIE UNFALLVERHÜTUNGSVORSCHRIFTEN DES ARBEITGEBERS SIND EBENFALLS ZU BEACHTEN.

<ul style="list-style-type: none"> ● Keep your head out of fumes. ● Use ventilation or exhaust to remove fumes from breathing zone. 	<ul style="list-style-type: none"> ● Turn power off before servicing. 	<ul style="list-style-type: none"> ● Do not operate with panel open or guards off. 	WARNING
<ul style="list-style-type: none"> ● Los humos fuera de la zona de respiración. ● Mantenga la cabeza fuera de los humos. Utilice ventilación o aspiración para gases. 	<ul style="list-style-type: none"> ● Desconectar el cable de alimentación de poder de la máquina antes de iniciar cualquier servicio. 	<ul style="list-style-type: none"> ● No operar con panel abierto o guardas quitadas. 	Spanish AVISO DE PRECAUCION
<ul style="list-style-type: none"> ● Gardez la tête à l'écart des fumées. ● Utilisez un ventilateur ou un aspirateur pour ôter les fumées des zones de travail. 	<ul style="list-style-type: none"> ● Débranchez le courant avant l'entretien. 	<ul style="list-style-type: none"> ● N'opérez pas avec les panneaux ouverts ou avec les dispositifs de protection enlevés. 	French ATTENTION
<ul style="list-style-type: none"> ● Vermeiden Sie das Einatmen von Schweißrauch! ● Sorgen Sie für gute Be- und Entlüftung des Arbeitsplatzes! 	<ul style="list-style-type: none"> ● Strom vor Wartungsarbeiten abschalten! (Netzstrom völlig öffnen; Maschine anhalten!) 	<ul style="list-style-type: none"> ● Anlage nie ohne Schutzgehäuse oder Innenschutzverkleidung in Betrieb setzen! 	German WARNUNG
<ul style="list-style-type: none"> ● Mantenha seu rosto da fumaça. ● Use ventilação e exaustão para remover fumo da zona respiratória. 	<ul style="list-style-type: none"> ● Não opere com as tampas removidas. ● Desligue a corrente antes de fazer serviço. ● Não toque as partes elétricas nuas. 	<ul style="list-style-type: none"> ● Mantenha-se afastado das partes moventes. ● Não opere com os painéis abertos ou guardas removidas. 	Portuguese ATENÇÃO
<ul style="list-style-type: none"> ● ヒュームから頭を離すようにして下さい。 ● 換気や排煙に十分留意して下さい。 	<ul style="list-style-type: none"> ● メンテナンス・サービスに取りかかる際には、まず電源スイッチを必ず切ってください。 	<ul style="list-style-type: none"> ● パネルやカバーを取り外したまま機械操作をしないで下さい。 	Japanese 注意事項
<ul style="list-style-type: none"> ● 頭部遠離煙霧。 ● 在呼吸區使用通風或排風器除煙。 	<ul style="list-style-type: none"> ● 維修前切斷電源。 	<ul style="list-style-type: none"> ● 儀表板打開或沒有安全罩時不準作業。 	Chinese 警告
<ul style="list-style-type: none"> ● 얼굴로부터 용접가스를 멀리하십시오. ● 호흡지역으로부터 용접가스를 제거하기 위해 가스제거기나 통풍기를 사용하십시오. 	<ul style="list-style-type: none"> ● 보수전에 전원을 차단하십시오. 	<ul style="list-style-type: none"> ● 판넬이 열린 상태로 작동치 마십시오. 	Korean 위험
<ul style="list-style-type: none"> ● ابعء رأسك بعيداً عن الدخان. ● استعمل التهوية أو جهاز ضغط الدخان للخارج لكي تبعد الدخان عن المنطقة التي تتنفس فيها. 	<ul style="list-style-type: none"> ● أقطع التيار الكهربائي قبل القيام بأية صيانة. 	<ul style="list-style-type: none"> ● لا تشغيل هذا الجهاز اذا كانت الاغطية الحديدية الواقية ليست عليه. 	Arabic تحذير

LEIA E COMPREENDA AS INSTRUÇÕES DO FABRICANTE PARA ESTE EQUIPAMENTO E AS PARTES DE USO, E SIGA AS PRÁTICAS DE SEGURANÇA DO EMPREGADOR.

使う機械や溶材のメーカーの指示書をよく読み、まず理解して下さい。そして貴社の安全規定に従って下さい。

請詳細閱讀並理解製造廠提供的說明以及應該使用的銀焊材料，並請遵守貴方的有閣勞動保護規定。

이 제품에 동봉된 작업지침서를 숙지하시고 귀사의 작업자 안전수칙을 준수하시기 바랍니다.

اقرأ بتمعن وافهم تعليمات المصنع المنتج لهذه المعدات والمواد قبل استعمالها واتبع تعليمات الوقاية لصاحب العمل.



• World's Leader in Welding and Cutting Products •

• Sales and Service through Subsidiaries and Distributors Worldwide •

Cleveland, Ohio 44117-1199 U.S.A. TEL: 216.481.8100 FAX: 216.486.1751 WEB SITE: www.lincolnelectric.com